

REV.	DESCRIPTION	DRAWN	DATE
1	INITIAL RELEASE	TIM	2020/06/10

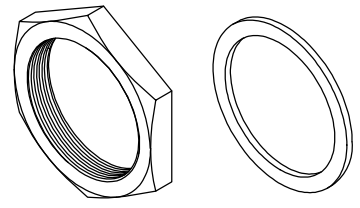
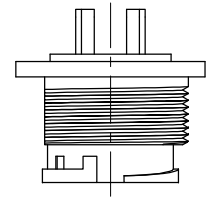
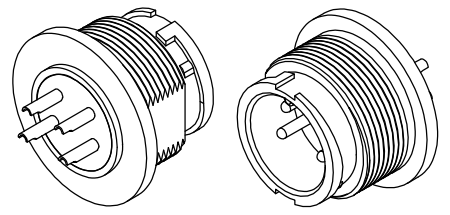

Nut Gasket

Accessories

**SPECIFICATION:**

1. Current Rating: 2A/ 5A/ 10A/ 20A per pin (see P2. table)
2. Contact Resistance: 10mΩ
3. Insulation Resistance: 100MΩ
4. Dielectric Withstanding Voltage: 500VAC
5. Durability: 1000 Cycle
6. Operating temperature range: -40°C~+85°C
7. Storage temperature range: -40°C~+85°C
8. Water Proof: IP67

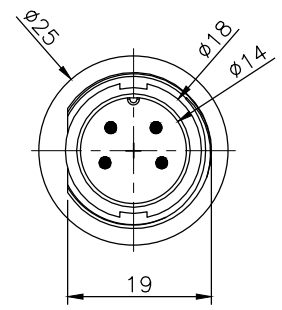
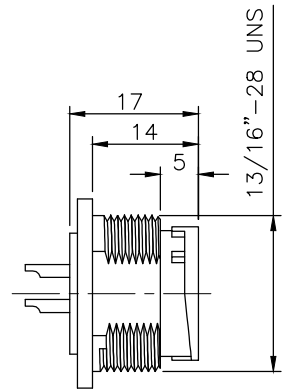

Body

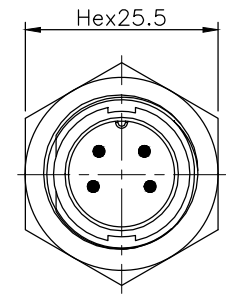

Assembly View

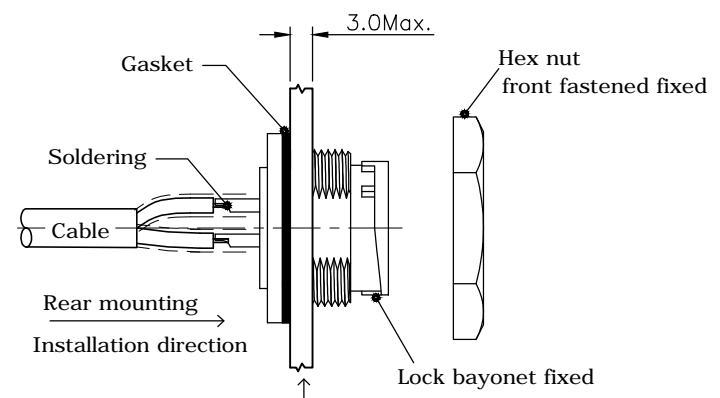
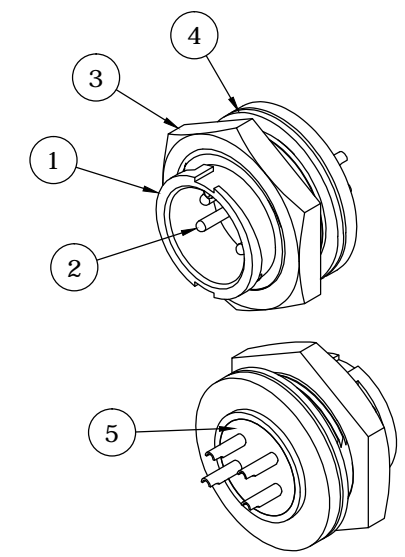
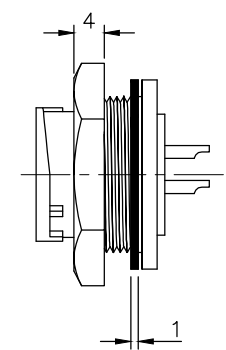

Rear side ← Panel → Front side  
(Inside) (Fixed plate) (Outside)

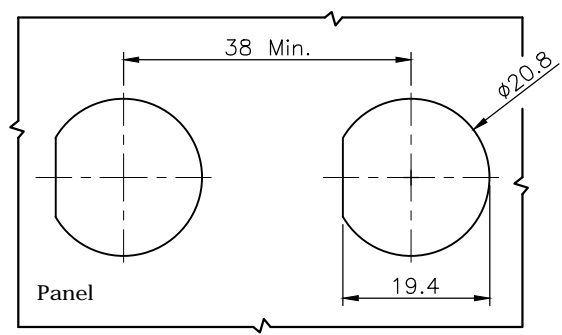

Recommend Panel Cut

5	GLUE	EPOXY
4	GASKET	Silicone, Gray
3	HEX NUT	PA66, UL94V-0, Black
2	CONTACT	Brass, 1u" Min. Gold Plating over Nickel
1	HOUSING	PA66, UL94V-0, Black

NO.		PART NAME		DESCRIPTION	
UNLESS OTHERWISE SPECIFIED TOLERANCE					
UNIT:	DECIMAL	LINEAR	ANGLES		
	X.	±0.50	±5°		
	X.X	±0.25	±3°		
	X.XX	±0.12	±1°		
DRAWN	Tim	2020/06/10	DRAWN NAME:		
CHECKED	Fros	2020/06/10	C Size Connector, Panel Fixed Front		
APPROVED	Ken	2020/06/10	Fastened Bayonet, M Skt M Solder Pin		
SCALE	1/1	SHEET	1/2	SIZE	A4
PRODUCT NO.		see page 2 table			
FILE NAME		227C-SMMO_B_1			



www.attend.com.tw

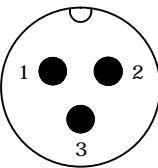
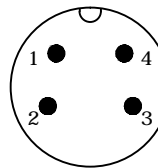
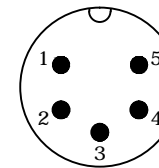
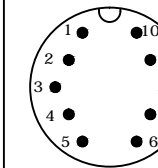
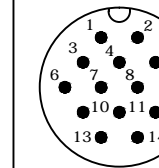
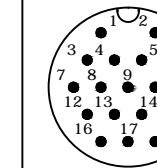
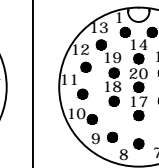

REV.	DESCRIPTION	DRAWN	DATE
	SEE SHEET ONE		

TABLE: Pin Count/ Pin Assignment/ Current Rating/ Part Number

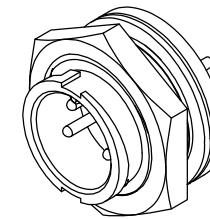
Part Number	227C-03M04	227C-04M04	227C-05M04	227C-10M03	227C-14M02	227C-18M02	227C-20M03
Pin Assignment							
Pin Count	3Pin	4Pin	5Pin	10Pin	14Pin	18Pin	20Pin
Current Rating	20A	10A	10A	2A	5A	2A	2A



Drawing Number: 227C-SMM0  
 Description: C size connector, panel fixed front fastened bayonet lock, male Socket male pin, solder bucket

UNLESS OTHERWISE SPECIFIED TOLERANCE				 www.attend.com.tw			
UNIT:	DECIMAL	LINEAR	ANGLES				
mm	X.	±0.50	±5°				
	X.X	±0.25	±3°				
	X.XX	±0.12	±1°				
DRAWN	Tim	2020/06/10	DRAWN NAME:				
CHECKED	Fros	2020/06/10	C Size Connector, Panel Fixed Front Fastened Bayonet, M Skt M Solder Pin				
APPROVED	Ken	2020/06/10	PRODUCT NO.	see table			
	SCALE 1/1	SHEET 2/2	SIZE A4	FILE NAME	227C-SMM0_B_1		

REV.	DESCRIPTION	DRAWN	DATE
1	INITIAL RELEASE	TIM	2020/06/10

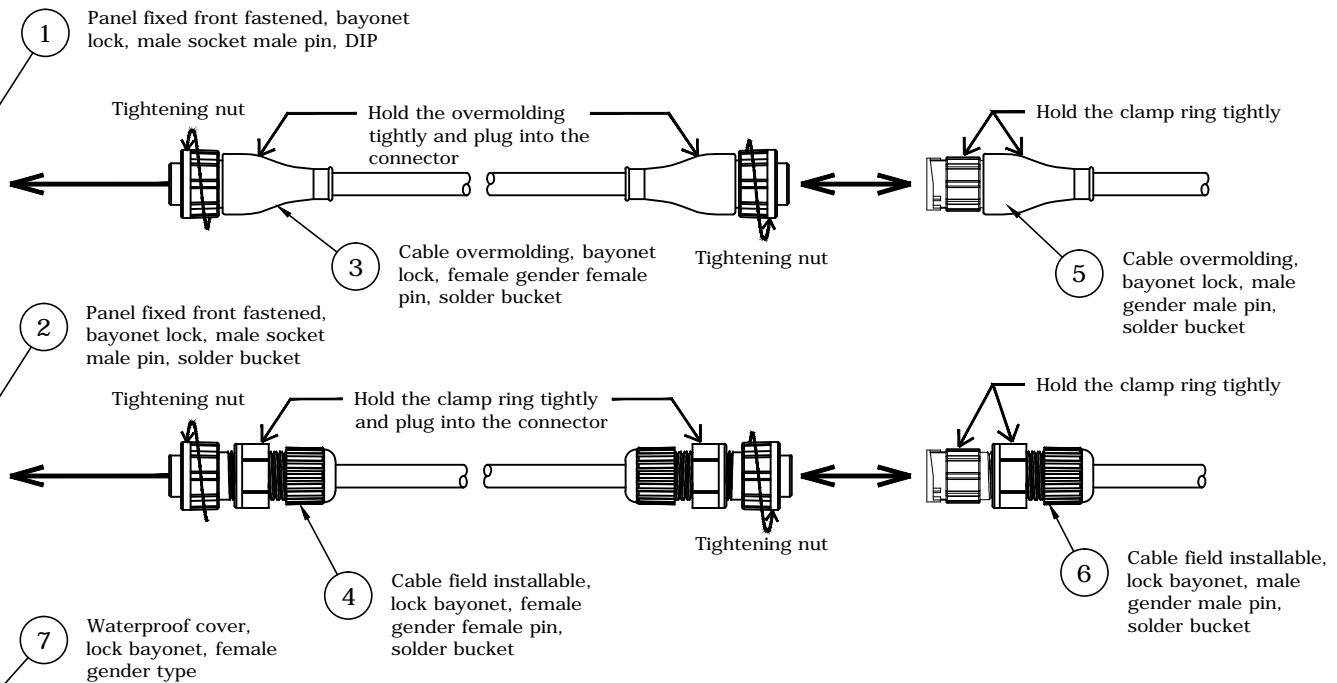
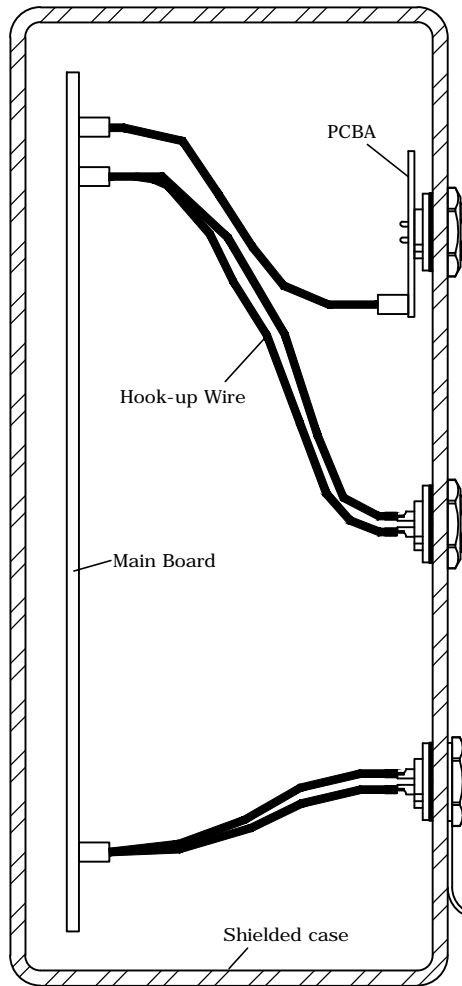

Application	Ball no.	Drawing Number	Gender		Matchable drawing numbers			
			Conn. type	Pin type	1	2	3	4
Panel Fixed	①	227C-DMMO	Male	Male	227C-MFFO	227C-AFFO	227C-0001	
	②	227C-SMMO			③	④	⑦	
Cable	③	227C-MFFO	Female	Female	227C-DMMO	227C-SMMO	227C-MMMO	227C-AMMO
	④	227C-AFFO			①	②	⑤	⑥
	⑤	227C-MMMO	Male	Male	227C-MFFO	227C-AFFO	227C-0001	
	⑥	227C-AMMO			③	④	⑦	
Accessories	⑦	227C-0001	Female		①	②	⑤	⑥

UNLESS OTHERWISE SPECIFIED TOLERANCE			
UNIT:	DECIMAL	LINEAR	ANGLES
mm	X.	±0.50	±5°
	X.X	±0.25	±3°
	X.XX	±0.12	±1°
DRAWN	Tim	2020/06/10	
CHECKED	Fros	2020/06/10	
APPROVED	Ken	2020/06/10	
SCALE	1/2	SHEET	1/1
		SIZE	A4



**ATTEND**

www.attend.com.tw

DRAWN NAME:  
C Size Water Proof Connector  
Application Drawing

PRODUCT NO.

FILE NAME: 227C-Series\_B\_1