

REV.	DESCRIPTION	DRAWN	DATE
1	INITIAL RELEASE	FROS	2016/08/17
2	CHANGE P/N	FROS	2016/10/11

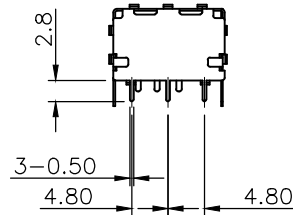

Back View

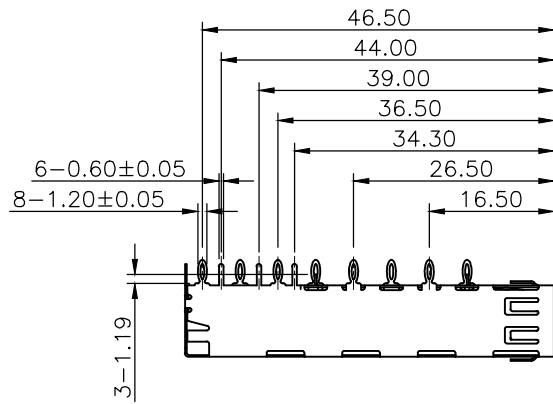
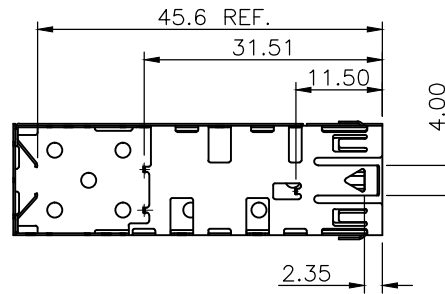
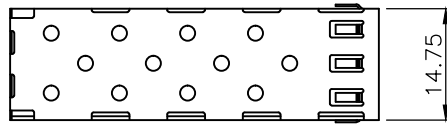

Bottom View

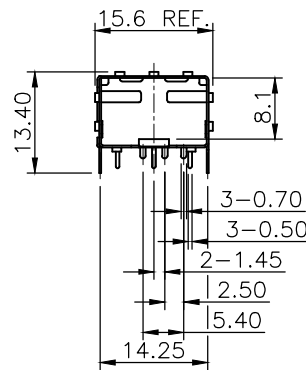
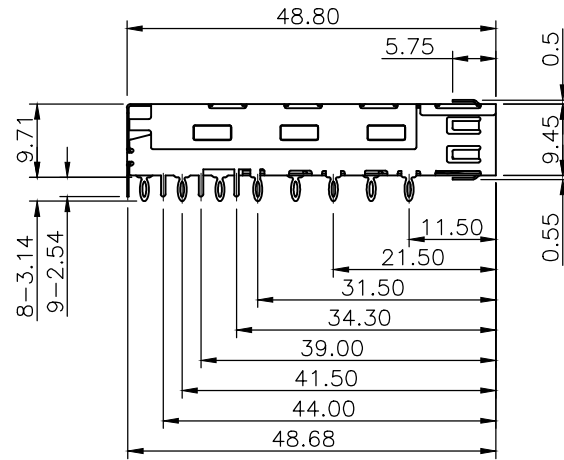

PACKAGING SPECIFICATION:

- 45pcs/ Vacuum Dish
- 990pcs/ Carton
- Vacuum Dish size: 330x290x19mm
- Carton: 340x300x427mm

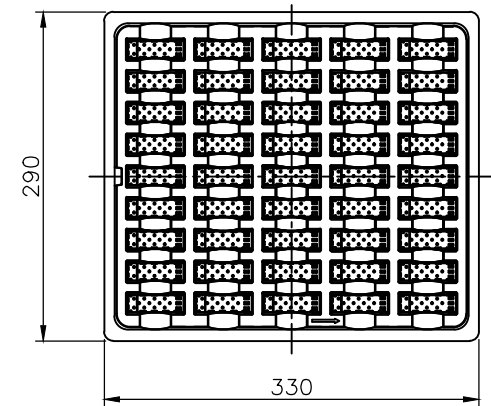



1	Cage	Copper Alloy 0.25t, Nickel Plating	
NO.	PART NAME	DESCRIPTION	
UNLESS OTHERWISE SPECIFIED TOLERANCE			
UNIT:	DECIMAL	LINEAR	ANGLES
mm	X.	±0.50	±5°
	X.X	±0.25	±3°
	X.XX	±0.12	±1°
WWW.ATTEND.COM.TW			
DRAWN	Fros	2016/08/17	DRAWN NAME:
CHECKED	Tim	2016/08/17	SFP Cage 1x1 Press Fit Type
APPROVED	Ken	2016/08/17	PRODUCT NO. 223A-1101
SCALE	1/1	SHEET	2
SIZE	A4	FILE NAME	223A-1101_B_2



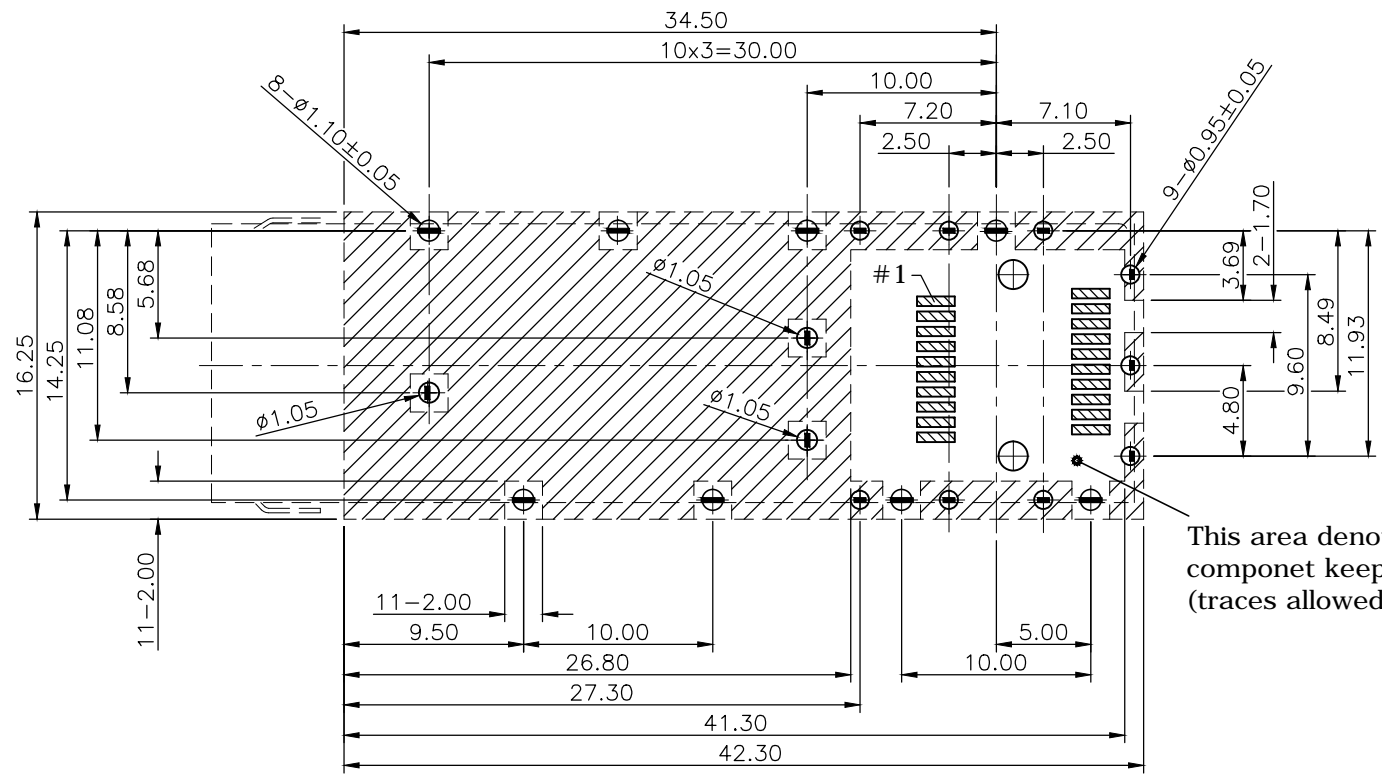

REV.	DESCRIPTION	DRAWN	DATE
	SEE SHEET ONE		



-  Cage Boundary
-  Component and trace keep-out (except chassis ground)
-  Connector PAD

This area denotes component keep-out (traces allowed)

Recommended Layout (top view)
General Tolerance: ±0.05mm

UNLESS OTHERWISE SPECIFIED TOLERANCE				 WWW.ATTEND.COM.TW		
UNIT:	DECIMAL	LINEAR	ANGLES			
mm	X.	±0.50	±5°			
	X.X	±0.25	±3°			
	X.XX	±0.12	±1°			
DRAWN	Fros	2016/08/17	DRAWN NAME:			
CHECKED	Tim	2016/08/17	SFP Cage 1x1 Press Fit Type			
APPROVED	Ken	2016/08/17	PRODUCT NO.	223A-1101		
	SCALE	SHEET	SIZE	FILE NAME		
	2.5/1	2/2	A4	223A-1101_B_2		

REV.	DESCRIPTION	DRAWN	DATE
3	Add new P/N to 5u" plating	FROS	2016/08/17
4	CHANGE P/N	FROS	2016/10/11
5	Corrected	FROS	2019/05/06

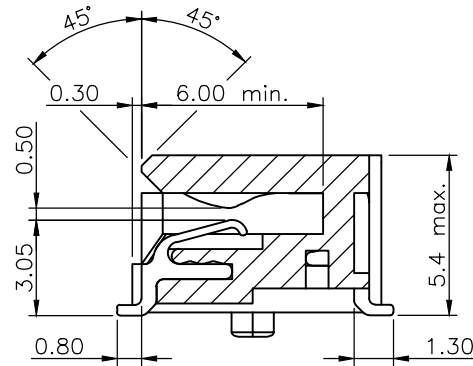
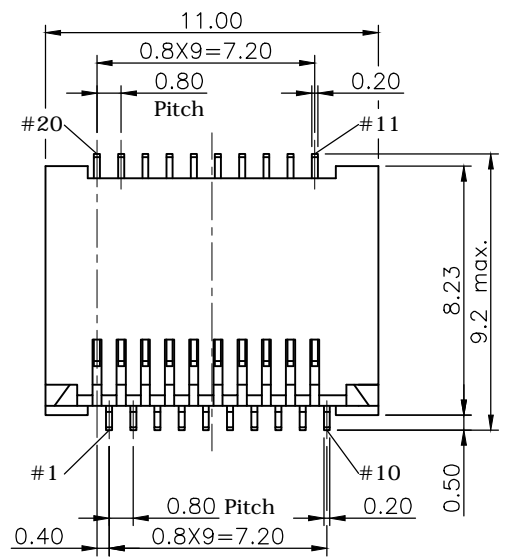

SECTION A-A

SPECIFICATION:

1. ELECTRICAL

- 1.1 Current Rating: 0.5A MAX.
- 1.2 Voltage Rating: 30V AC/DC
- 1.3 Contact Resistance: 20mΩ
- 1.4 Insulation Resistance: 500MΩ
- 1.5 Differential Impedance: 100Ω

2. MECHANICAL

2.1 MATERIAL:

- Housing: LCP UL94V-0, Black
- Contact: Phosphor Bronze, 0.2T
- 2.2 Operating Life : 250 Cycles Min.

3. ENVIRONMENTAL

- 3.1 Operating temperature range: -40°C ~ +85°C
- 3.2 Storage temperature range: -40°C ~ +85°C
- 3.3 IR Temperature: 255°C±5°C (5 to 10 sec)

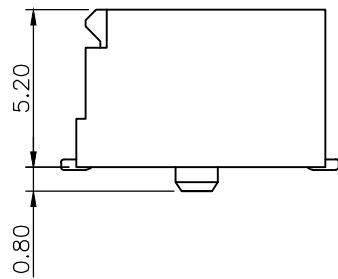
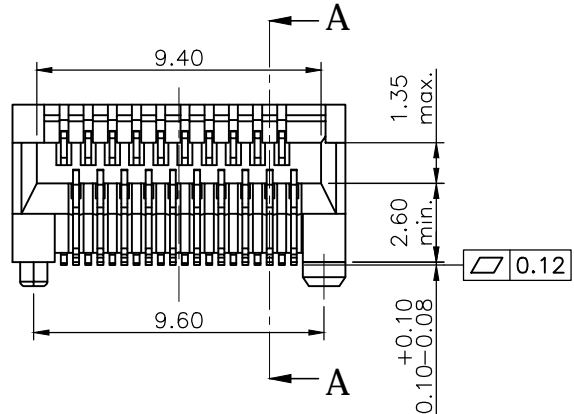

How to order

223A- 00 C 0

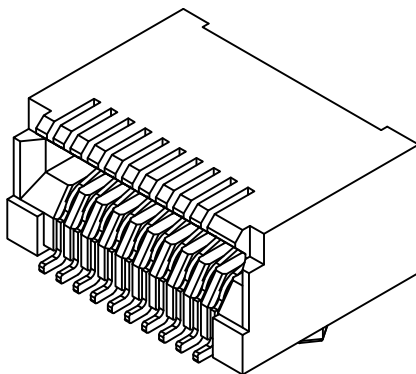
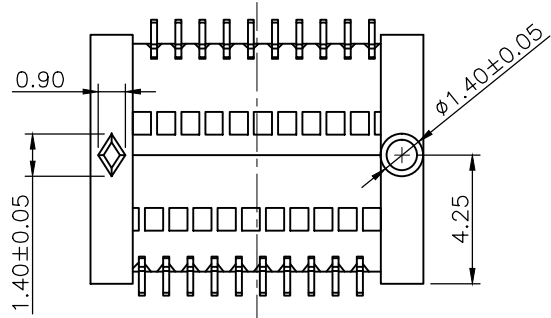
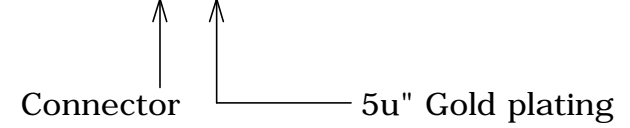

UNLESS OTHERWISE SPECIFIED TOLERANCE						
UNIT:	DECIMAL	LINEAR	ANGLES			
mm	X.	±0.50	±5°	WWW.ATTEND.COM.TW		
	X.X	±0.25	±3°			
	X.XX	±0.12	±1°			
DRAWN	Willis	2009/10/14	DRAWN NAME: 1x1 SFP/SFP+ Connector 20Pin			
CHECKED	Angel	2009/10/14				
APPROVED	Ken	2009/10/14	PRODUCT NO.	223A-00C0		
	SCALE	4/1	SHEET	1/2	SIZE	A4
			FILE NAME	223A-00C0_B_5		

REV.	DESCRIPTION	DRAWN	DATE
	SEE SHEET ONE		

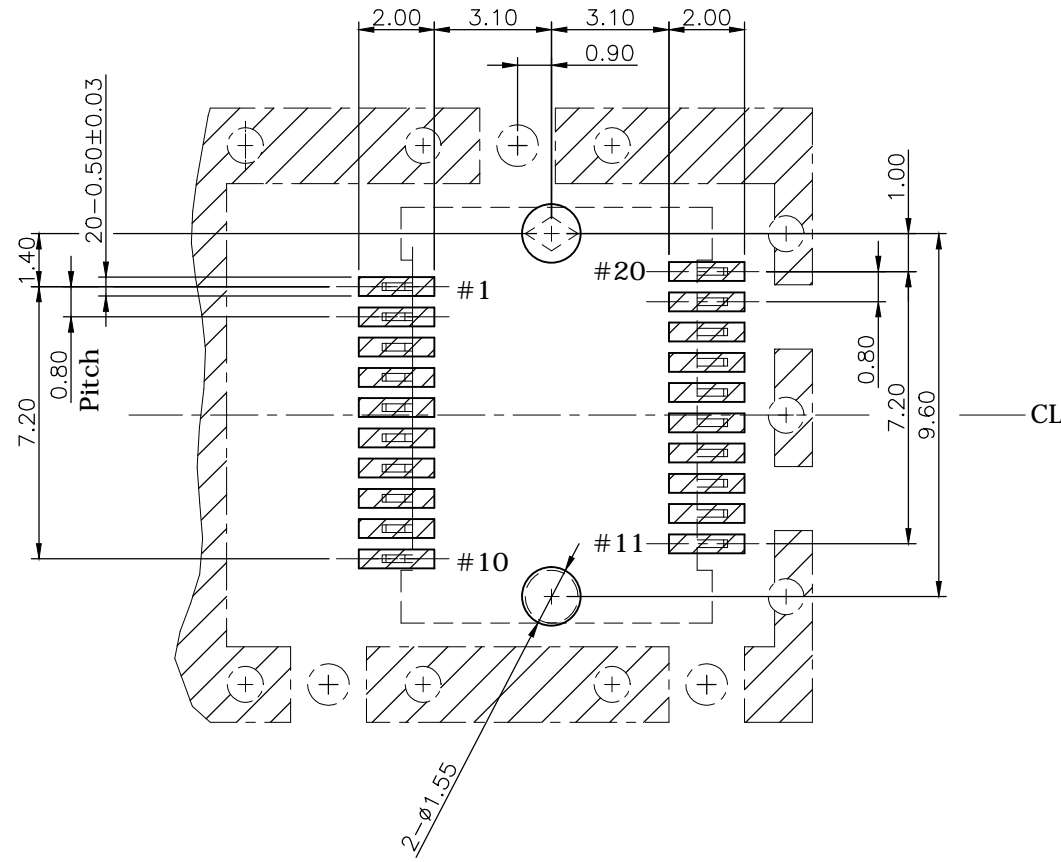

- SFP CONNECTOR
- ▨ PAD
- ▨ CAGE

RECOMMENDED LAYOUT (TOP VIEW)
GENERAL TOLERANCE: ±0.05mm

UNLESS OTHERWISE SPECIFIED TOLERANCE				 WWW.ATTEND.COM.TW
UNIT:	DECIMAL	LINEAR	ANGLES	
mm	X.	±0.50	±5°	
	X.X	±0.25	±3°	
	X.XX	±0.12	±1°	
DRAWN	Willis	2009/10/14	DRAWN NAME:	
CHECKED	Angel	2009/10/14	1x1 SFP/SFP+ Connector 20Pin	
APPROVED	Ken	2009/10/14	PRODUCT NO. 223A-00C0	
SCALE	5/1	SHEET 2/2	SIZE A4	FILE NAME 223A-00C0_B_5