

REV.	DESCRIPTION	DRAWN	DATE
1	INITIAL RELEASE	FROS	2022/08/29

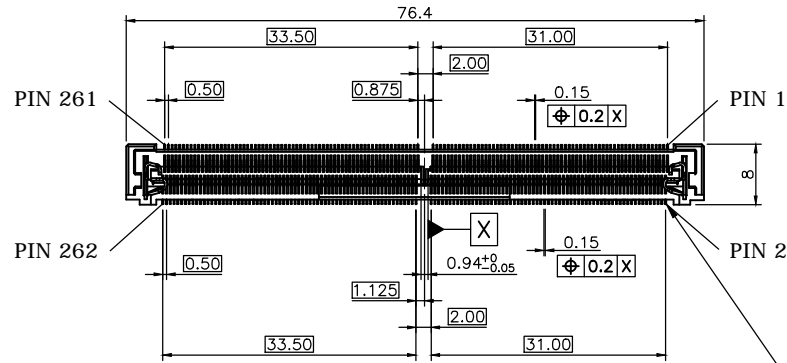

SPECIFICATION:

1. ELECTRICAL
 - 1.1 Current Rating: 0.6A per pin
 - 1.2 Voltage Rating: 25V AC
 - 1.3 Contact Resistance: 60mΩ max.
 - 1.4 Insulation Resistance: 100MΩ
 - 1.5 Dielectric Withstanding Voltage: 500VAC
2. MECHANICAL
 - 2.1 Durability: 50 Cycle
 - 2.2 Insertion Force: 59.8N max.
- 2.3 Extraction Force: 44.6N max.
3. ENVIRONMENTAL
 - 3.1 Operating temperature range: -55°C~+85°C
 - 3.2 Storage temperature range: -55°C~+85°C
4. SOLDER ABILITY
 - 4.1 Recommended IR-Reflow Temperature: 260°C

DATE CODE: YWWD

Y: YEAR
 WW: WEEK (01~52)
 D: DAY (1~7)

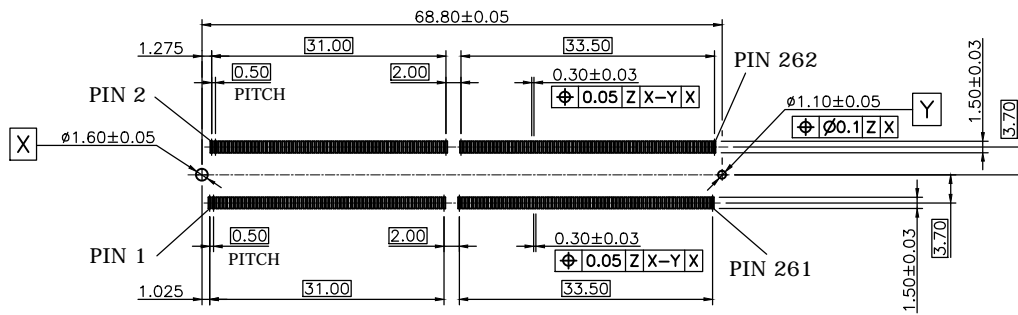
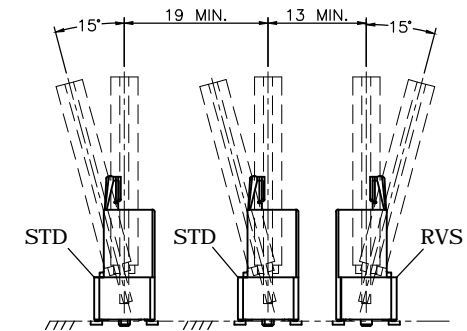
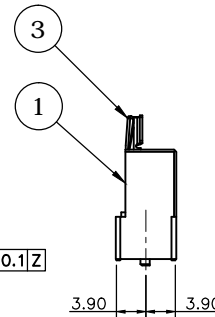
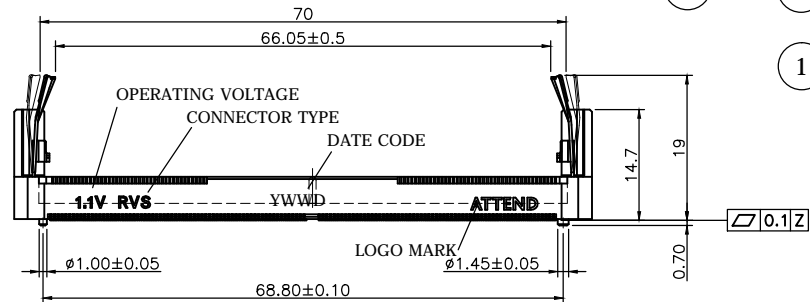

RECOMMENDED PCB LAYOUT (TOP VIEW)
 GENERAL TOLERANCE: ±0.05mm



RECOMMENDED SOCKET MOUNTING LAYOUT

3	LATCH	STAINLESS STEEL		
2	CONTACT	PHOSPHOR BRONZE, GOLD FLASH		
1	HOUSING	LCP, UL94V-0, BLACK		
NO.	PART NAME	DESCRIPTION		
UNLESS OTHERWISE SPECIFIED TOLERANCE				
UNIT:	DECIMAL	LINEAR	ANGLES	
	mm	X, ±0.50	±5°	
		X.X, ±0.25	±3°	
		X.XX, ±0.12	±1°	
DRAWN		Fros	2021/12/03	 www.attend.com.tw
CHECKED		Tim	2021/12/03	
APPROVED		Ken	2021/12/03	
SCALE		1/1	SIZE A4	
DRAWN NAME:		DDR5 SODIMM Socket, Vertical 19H, RVS, G/F, Black, Tray		
PRODUCT NO.		126B-190A10		
FILE NAME		126B-190A10_B_1		

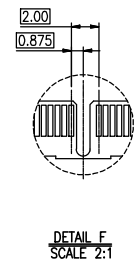
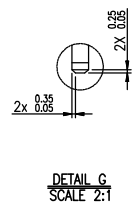
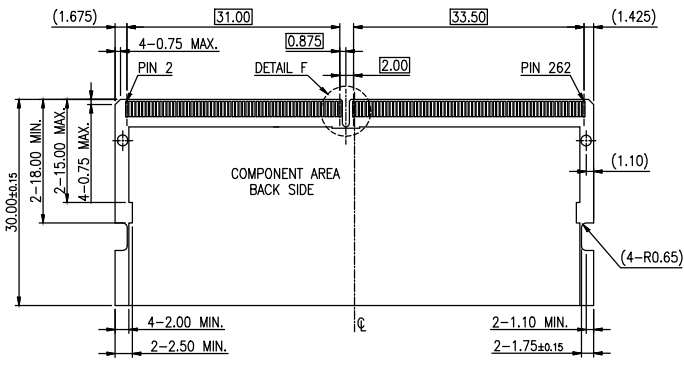
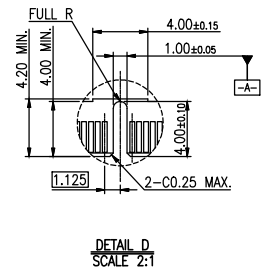
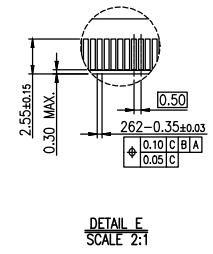
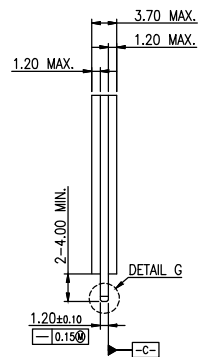
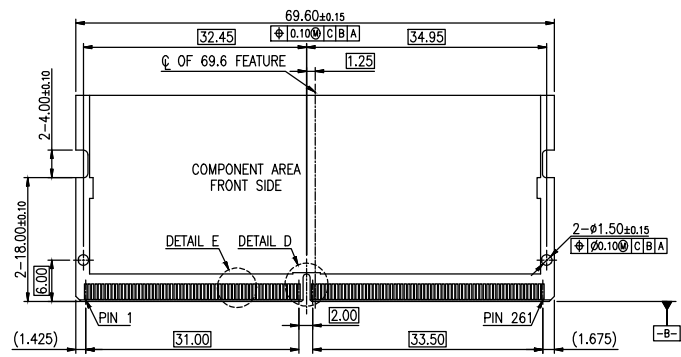
REV.	DESCRIPTION	DRAWN	DATE
1	INITIAL RELEASE	FROS	2021/03/23



RECOMMEND MODULE CONFIGURATION

UNLESS OTHERWISE SPECIFIED TOLERANCE				 www.attend.com.tw	
UNIT:	DECIMAL	LINEAR	ANGLES		
mm	X.	±0.50	±5°		
	X.X	±0.25	±3°		
	X.XX	±0.12	±1°		
DRAWN	Fros	2021/03/23	DRAWN NAME:		
CHECKED	Tim	2021/03/23	262 PIN DDR5 SODIMM, 0.5MM PITCH PACKAGE		
APPROVED	Ken	2021/03/23	PRODUCT NO.		
	SCALE	SHEET	SIZE	FILE NAME	
	1.25	1/1	A4	126A-CARD_B_1	

REV.	DESCRIPTION	DRAWN	DATE
1	Initial Release	TIM	2023/01/09
2	ECR2300004	Fros	2023/05/30

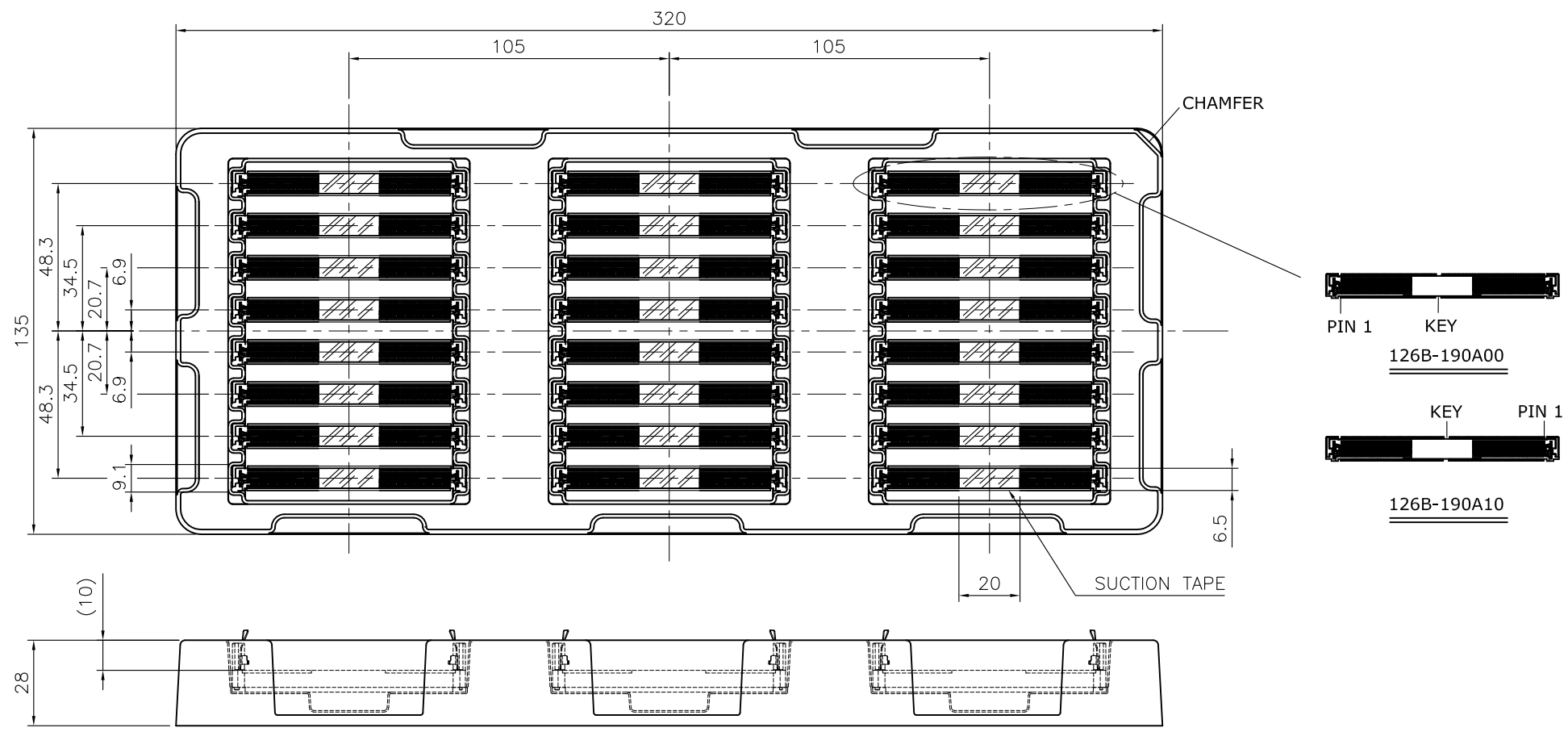

P/N	QTY/TRAY	INNER BOX	CARTON
126B-190A00	24	192	576
126B-190A10	24	192	576

UNLESS OTHERWISE SPECIFIED TOLERANCE

UNIT:	DECIMAL	LINEAR	ANGLES
mm	X.	±0.50	±5°
	X.X	±0.25	±3°
	X.XX	±0.12	±1°

ATTEND
WWW.ATTEND.COM.TW

DRAWN	Tim	2022/10/11	DRAWN NAME: DDR5 SODIMM Socket, Vertical Packaging	
CHECKED	Fros	2022/10/11	PRODUCT NO.	SEE TABLE
APPROVED	Ken	2022/10/11	FILE NAME	126B-190AX0_D_2

SCALE 1/2 SHEET 1/1 SIZE A4