

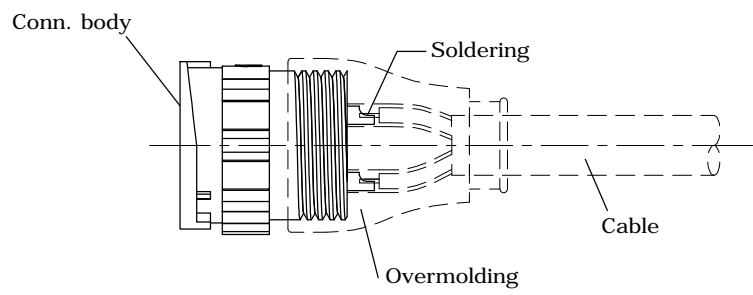

REV.	DESCRIPTION	DRAWN	DATE
1	INITIAL RELEASE	TIM	2020/06/10

SPECIFICATION:

1. Current Rating: 5A/ 20A per pin (see P2. table)
2. Contact Resistance: 10mΩ
3. Insulation Resistance: 100MΩ
4. Dielectric Withstanding Voltage: 500VAC
5. Durability: 1000 Cycle
6. Operating temperature range: -40°C~+85°C
7. Storage temperature range: -40°C~+85°C
8. Water Proof: IP67

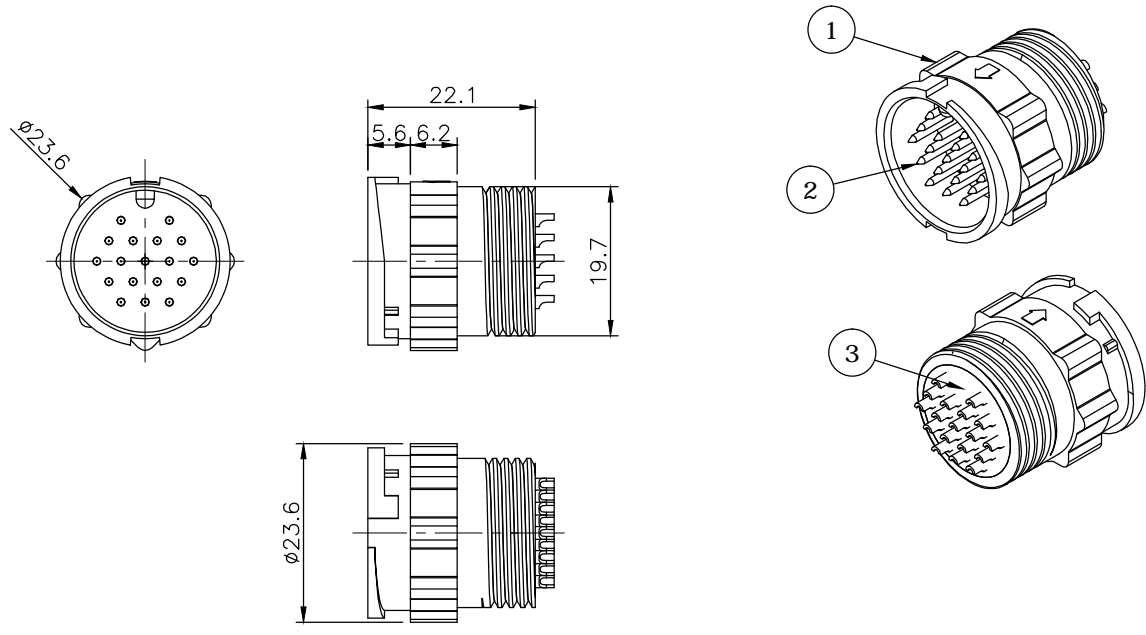

Cable overmolding, bayonet lock, female gender female pin, solder bucket

3	GLUE	EPOXY		
2	CONTACT	Brass, 1u' Min. Gold Plating over Nickel		
1	HOUSING	PA66, UL94V-0, Black		
NO.	PART NAME	DESCRIPTION		
UNLESS OTHERWISE SPECIFIED TOLERANCE				
UNIT:	DECIMAL	LINEAR	ANGLES	
mm	X.	±0.50	±5°	
	X.X	±0.25	±3°	
	X.XX	±0.12	±1°	
		 www.attend.com.tw		
DRAWN	Tim	2020/06/10	DRAWN NAME:	
CHECKED	Fros	2020/06/10	D Size Connector, Overmolding Cable Lock Bayonet, M Skt M Solder Pin	
APPROVED	Ken	2020/06/10	PRODUCT NO. see page 2 table	
	SCALE 1/1	SHEET 1/2	SIZE A4	FILE NAME 227D-MMM0_B_1

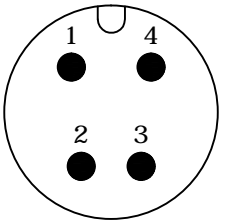
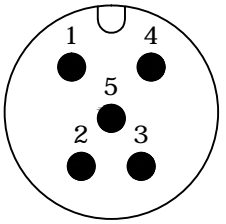
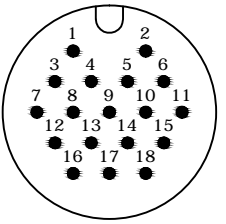

REV.	DESCRIPTION	DRAWN	DATE
	SEE SHEET ONE		

TABLE: Pin Count/ Pin Assignment/ Current Rating/ Part Number

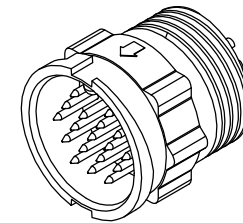
Part Number	227D-04M02	227D-05M04	227D-18M18
Pin Assignment			
Pin Count	4Pin	5Pin	18Pin
Current Rating	20A	20A	5A



Drawing Number: 227D-MMM0
 Description: D size connector, overmolding cable lock bayonet, male socket male pin, solder bucket

UNLESS OTHERWISE SPECIFIED TOLERANCE				 ATTEND www.attend.com.tw		
UNIT:	DECIMAL	LINEAR	ANGLES			DRAWN NAME: D Size Connector, Overmolding Cable Lock Bayonet, M Skt M Solder Pin
mm	X.	±0.50	±5°			
	X.X	±0.25	±3°			
	X.XX	±0.12	±1°			
DRAWN	Tim	2020/06/10	PRODUCT NO.	see table		
CHECKED	Fros	2020/06/10	FILE NAME	227D-MMM0_B_1		
APPROVED	Ken	2020/06/10	SCALE	1/1		
		SHEET	SIZE			
		2/2	A4			

REV.	DESCRIPTION	DRAWN	DATE
1	INITIAL RELEASE	TIM	2020/06/10

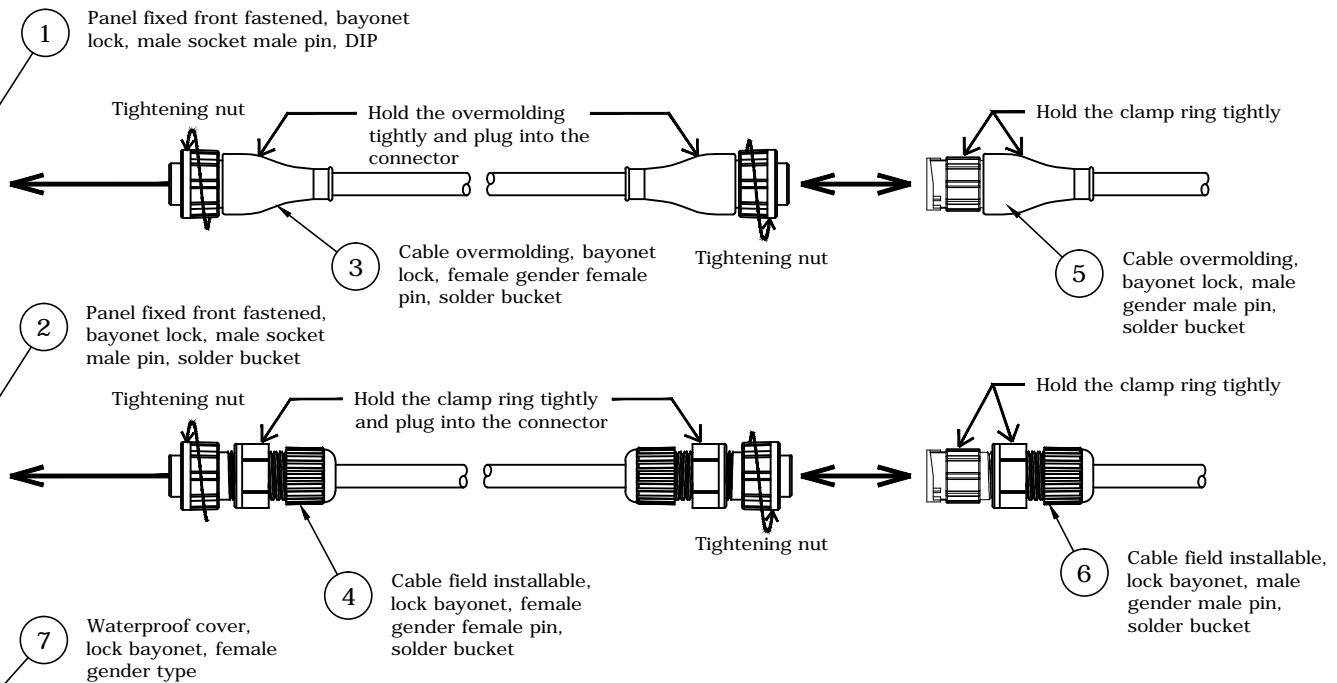
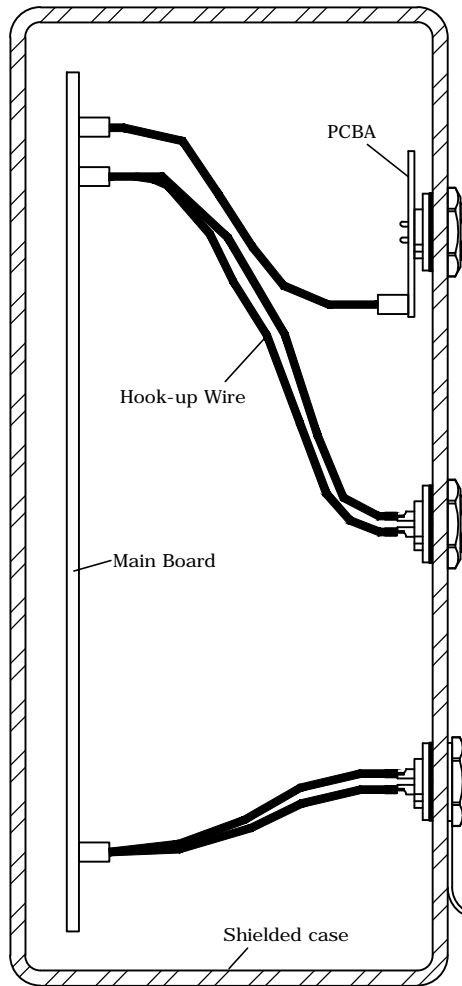

Application	Ball no.	Drawing Number	Gender		Matchable drawing numbers			
			Conn. type	Pin type	1	2	3	4
Panel Fixed	①	227D-DMM0	Male	Male	227D-MFF0	227D-AFF0	227D-0001	
	②	227D-SMM0			③	④	⑦	
Cable	③	227D-MFF0	Female	Female	227D-DMM0	227D-SMM0	227D-MMM0	227D-AMM0
	④	227D-AFF0			①	②	⑤	⑥
	⑤	227D-MMM0	Male	Male	227D-MFF0	227D-AFF0	227D-0001	
⑥	227D-AMM0	③			④	⑦		
Accessories	⑦	227D-0001	Female		①	②	⑤	⑥

UNLESS OTHERWISE SPECIFIED TOLERANCE			
UNIT:	DECIMAL	LINEAR	ANGLES
mm	X.	±0.50	±5°
	X.X	±0.25	±3°
	X.XX	±0.12	±1°
DRAWN	Tim	2020/06/10	
CHECKED	Fros	2020/06/10	
APPROVED	Ken	2020/06/10	
SCALE	1/2	SHEET	1/1
		SIZE	A4



ATTEND

www.attend.com.tw

DRAWN NAME:
D Size Water Proof Connector
Application Drawing

PRODUCT NO.:

FILE NAME: 227D-Series_B_1