

REV.	DESCRIPTION	DRAWN	DATE
1	INITIAL RELEASE	FROS	2020/06/10

SPECIFICATION:

1. Current Rating: 2A/ 5A per pin (see P2. table)
2. Contact Resistance: 10mΩ
3. Insulation Resistance: 100MΩ
4. Dielectric Withstanding Voltage: 500VAC
5. Durability: 1000 Cycle
6. Operating temperature range: -40°C~+85°C
7. Storage temperature range: -40°C~+85°C
8. Water Proof: IP67

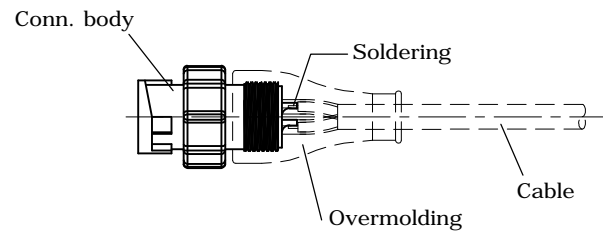
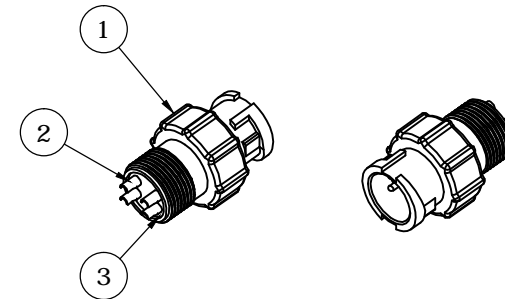
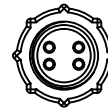
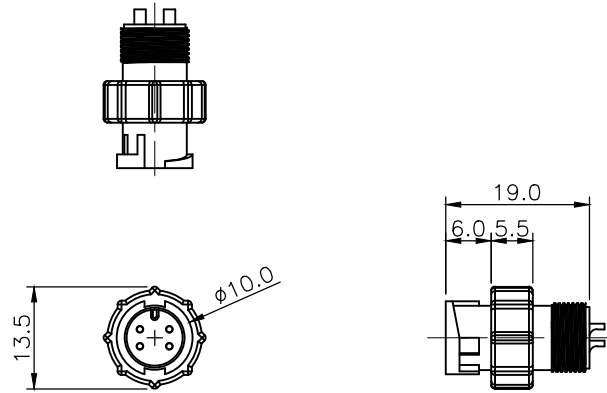

Cable overmolding, bayonet lock, male gender male pin, solder bucket

3	GLUE	EPOXY
2	CONTACT	Brass, 1u" Min. Gold Plating over Nickel
1	HOUSING	PA66, UL94V-0, Black
NO.	PART NAME	DESCRIPTION
UNLESS OTHERWISE SPECIFIED TOLERANCE		
UNIT:	DECIMAL	LINEAR ANGLES
mm	X.	±0.50 ±5°
	X.X	±0.25 ±3°
	X.XX	±0.12 ±1°
DRAWN		Fros 2020/06/10
CHECKED		Tim 2020/06/10
APPROVED		Ken 2020/06/10
SCALE		1/1
SHEET		1/2
SIZE		A4
DRAWN NAME:		A Size Connector, Overmolding Cable Lock Bayonet, M Skt M Solder Pin
PRODUCT NO.		see page 2 table
FILE NAME		227A-MMM0_B_1



www.attend.com.tw

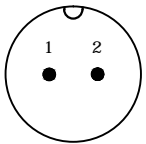
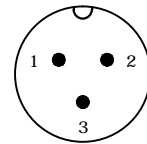
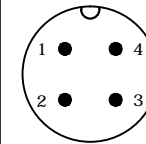
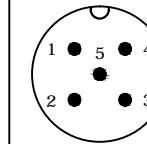
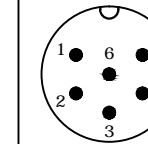

REV.	DESCRIPTION	DRAWN	DATE
	SEE SHEET ONE		

TABLE: Pin Count/ Pin Assignment/ Current Rating/ Part Number

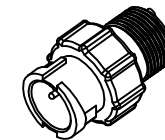
Part Number	227A-02M04	227A-03M04	227A-04M04	227A-05M04	227A-06M04
Pin Assignment					
Pin Count	2Pin	3Pin	4Pin	5Pin	6Pin
Current Rating	5A	5A	2A	2A	2A



Drawing Number: 227A-MMM0
 Description: A size connector, overmolding cable lock bayonet, male socket male pin, solder bucket

UNLESS OTHERWISE SPECIFIED TOLERANCE				 ATTEND www.attend.com.tw
UNIT:	DECIMAL	LINEAR	ANGLES	
mm	X.	±0.50	±5°	
	X.X	±0.25	±3°	
	X.XX	±0.12	±1°	
DRAWN	Fros	2020/06/10	DRAWN NAME:	
CHECKED	Tim	2020/06/10	A Size Connector, Overmolding Cable Lock Bayonet, M Skt M Solder Pin	
APPROVED	Ken	2020/06/10	PRODUCT NO. see table	
	SCALE 1/1	SHEET 2/2	SIZE A4	FILE NAME 227A-MMM0_B_1

REV.	DESCRIPTION	DRAWN	DATE
1	INITIAL RELEASE	FROS	2020/06/10

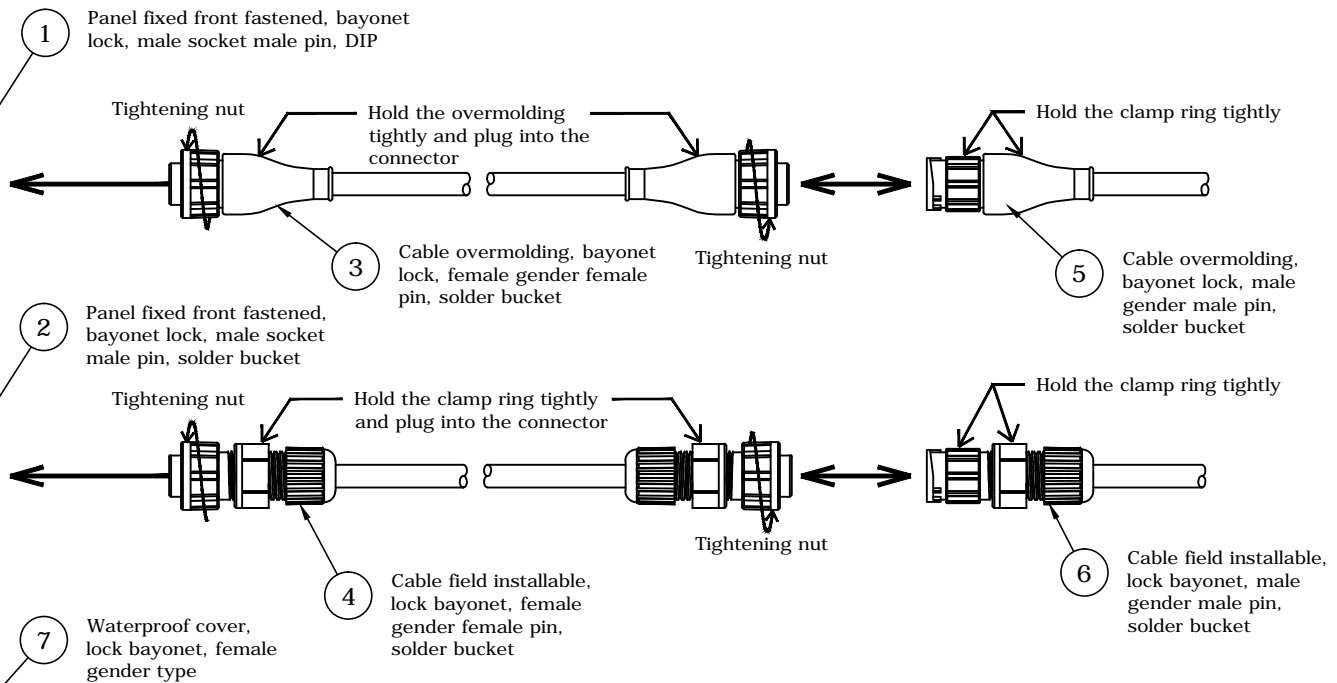
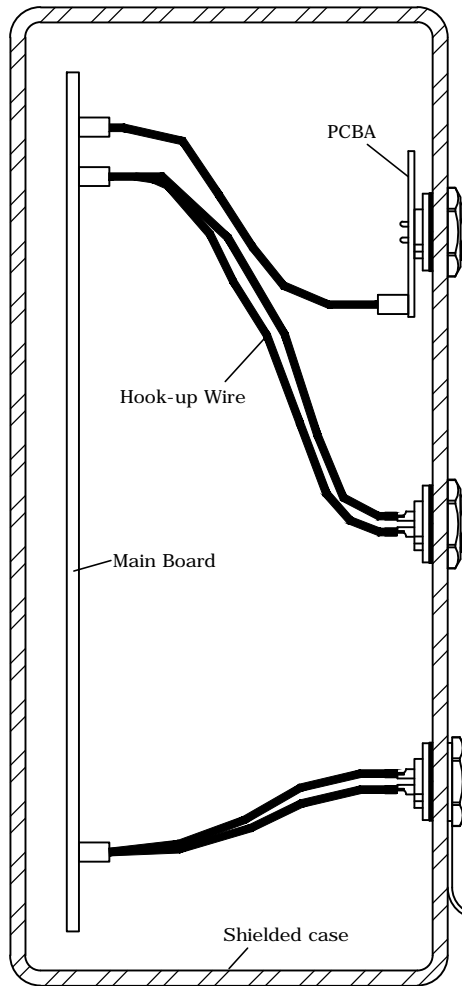

Application	Ball no.	Drawing Number	Gender		Matchable drawing numbers			
			Conn. type	Pin type	1	2	3	4
Panel Fixed	①	227A-DMMO	Male	Male	227A-MFFO	227A-AFFO	227A-0001	
	②	227A-SMMO			③	④	⑦	
Cable	③	227A-MFFO	Female	Female	227A-DMMO	227A-SMMO	227A-MMMO	227A-AMMO
	④	227A-AFFO			①	②	⑤	⑥
	⑤	227A-MMMO	Male	Male	227A-MFFO	227A-AFFO	227A-0001	
	⑥	227A-AMMO			③	④	⑦	
Accessories	⑦	227A-0001	Female		①	②	⑤	⑥

UNLESS OTHERWISE SPECIFIED TOLERANCE

UNIT:	DECIMAL	LINEAR	ANGLES
mm	X. ±0.50	±0.50	±5°
	X.X ±0.25	±0.25	±3°
	X.XX ±0.12	±0.12	±1°

DRAWN	Fros	2020/06/10
CHECKED	Tim	2020/06/10
APPROVED	Ken	2020/06/10
SCALE	1/2	
SHEET	1/1	
SIZE	A4	

www.attend.com.tw

DRAWN NAME: A Size Connector, Application Drawing

PRODUCT NO.

FILE NAME: 227A-Series_B_1