

REV.	DESCRIPTION	DRAWN	DATE
1	INITIAL RELEASE	TIM	2017/03/07

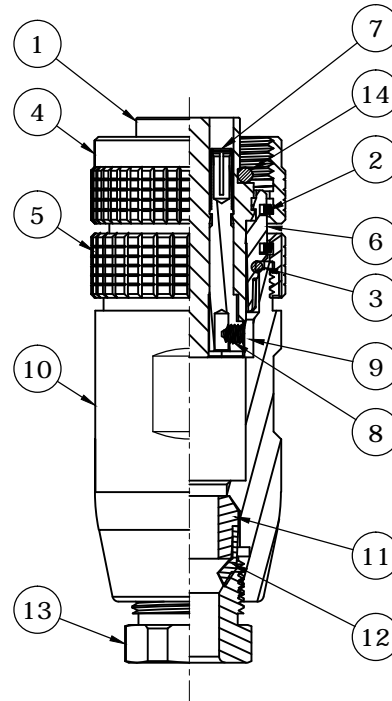
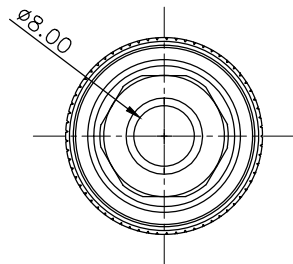
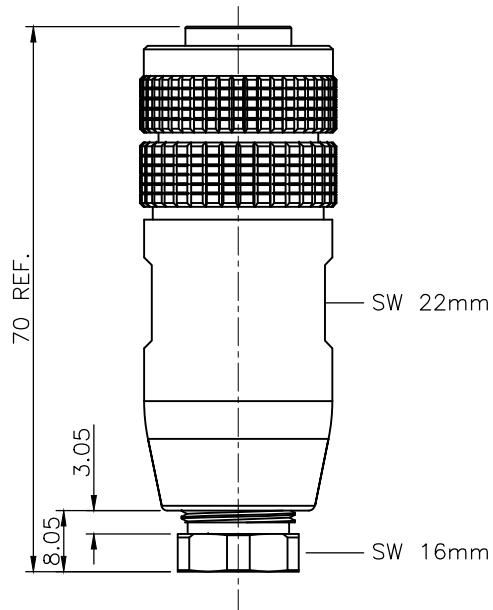
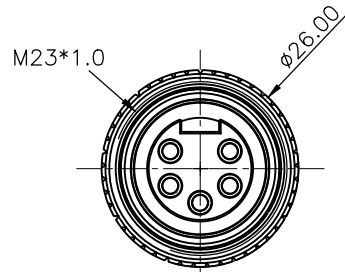

SPECIFICATION:

- CURRENT RATING: 20A
- VOLTAGE: 250V
- WATER PROOF: IP67
- OPERATION TEMPERATURE: -40°C TO +85°C

NOTE:

Applicable Cable Outer Diameter: $\phi 6.5$ to $\phi 8.0$ mm

14	O-RING C	NBR, Black
13	NUT C	Aluminium alloy, Nickel plating
12	GLAND CAGE	POM, White
11	GLAND	Silicone, Black
10	BODY	Aluminium alloy, Nickel plating
9	O-RING B	Silicone, Black
8	SCREW	Alloy steel, Nickel plating
7	CONTACT	Brass, Gold plating over Nickel
6	SHELL	Aluminium alloy, Nickel plating
5	NUT B	Brass, Nickel plating
4	NUT A	Brass, Nickel plating
3	O-RING A	NBR, Black
2	SPRING	Stainless steel
1	HOUSING	TPU, UL94V-0, Yellow
NO.	PART NAME	DESCRIPTION

UNLESS OTHERWISE SPECIFIED TOLERANCE

UNIT:	DECIMAL	LINEAR	ANGLES
mm	X.	± 0.50	$\pm 5^\circ$
	X.X	± 0.25	$\pm 3^\circ$
	X.XX	± 0.12	$\pm 1^\circ$



WWW.ATTEND.COM.TW

DRAWN	Tim	2017/03/07	DRAWN NAME:
CHECKED	Fros	2017/03/07	M23 A- Code Plug for Cable, 5Pin Female For Field Installable
APPROVED	Ken	2017/03/07	PRODUCT NO. 221A-05FF0
	SCALE 1/1	SHEET 1/1	SIZE A4
	FILE NAME	221A-05FF0_B_1	

REV.	DESCRIPTION	DRAWN	DATE
------	-------------	-------	------

1. Pre-assembled

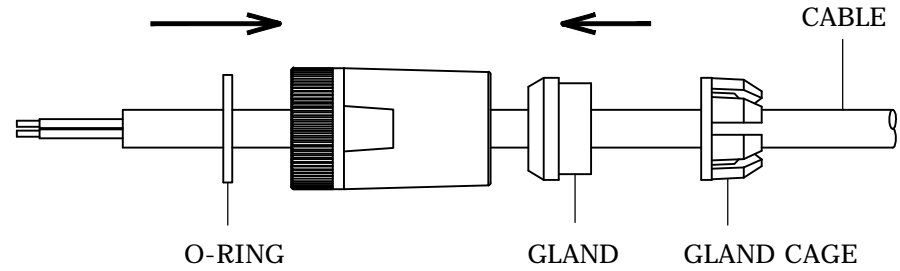

2. Wire Processing

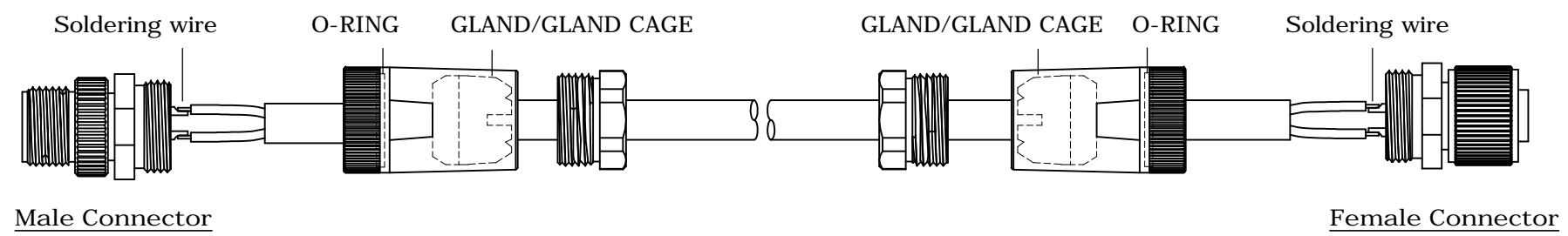

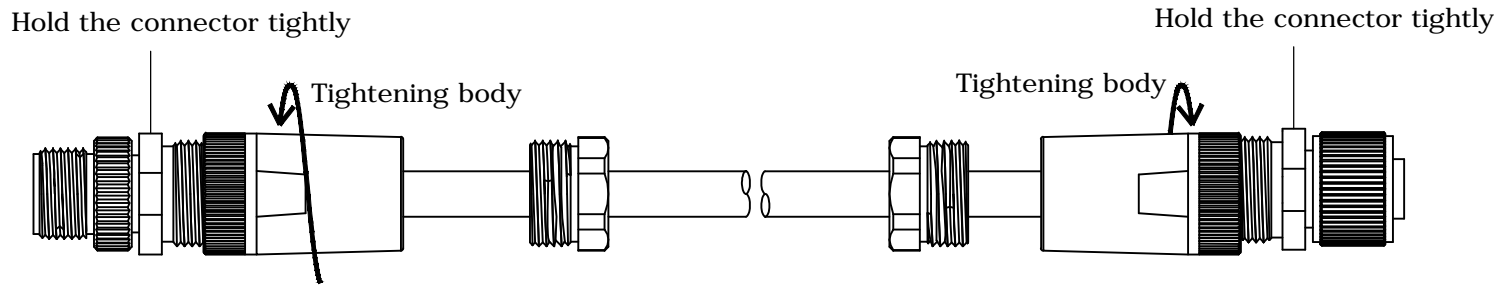

3. Setting Connector

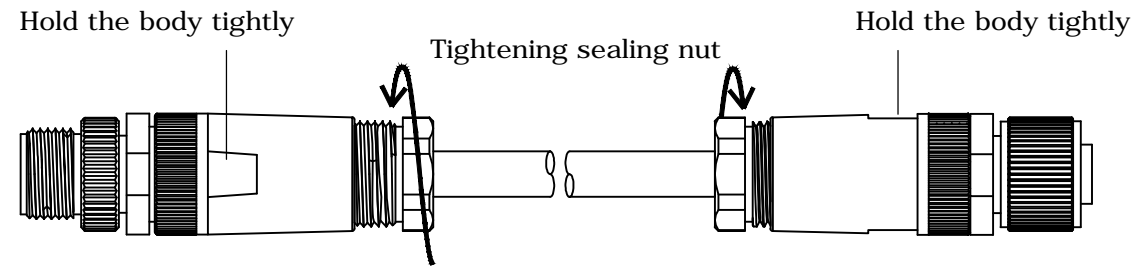

4. Assembly Sealing Nut



UNLESS OTHERWISE SPECIFIED TOLERANCE				 WWW.ATTEND.COM.TW	
UNIT:	DECIMAL	LINEAR	ANGLES		
mm	X.	±0.50	±5°		
	X.X	±0.25	±3°		
	X.XX	±0.12	±1°		
DRAWN	Tim	2025/02/25	DRAWN NAME: M Series For Female Field Installable Type Design Guide		
CHECKED	Fros	2025/02/25	PRODUCT NO.		
APPROVED	Ken	2025/02/25	FILE NAME		
		SCALE	SHEET 1/1	SIZE A4	M Series FFO_DG