

REV.	DESCRIPTION	DRAWN	DATE
1	INITIAL RELEASE	FROS	2021/03/23

DATE CODE: YYWWD
 YY: YEAR
 WW: WEEK(01~52)
 D: DAY (1~7)

SPECIFICATION:

1. ELECTRICAL
 - 1.1 Current Rating: 0.6A per pin
 - 1.2 Voltage Rating: 25V AC
 - 1.3 Contact Resistance: 60mΩ max.
 - 1.4 Insulation Resistance: 100MΩ
 - 1.5 Dielectric Withstanding Voltage: 500VAC
2. MECHANICAL
 - 2.1 Durability: 50 Cycle
 - 2.2 Insertion Force: 59.8N max.
 - 2.3 Extraction Force: 44.6N max.
3. ENVIRONMENTAL
 - 3.1 Operating temperature range: -40°C~+85°C
 - 3.2 Storage temperature range: -40°C~+85°C
4. SOLDER ABILITY
 - 4.1 Recommended IR-Reflow Temperature: 260°C

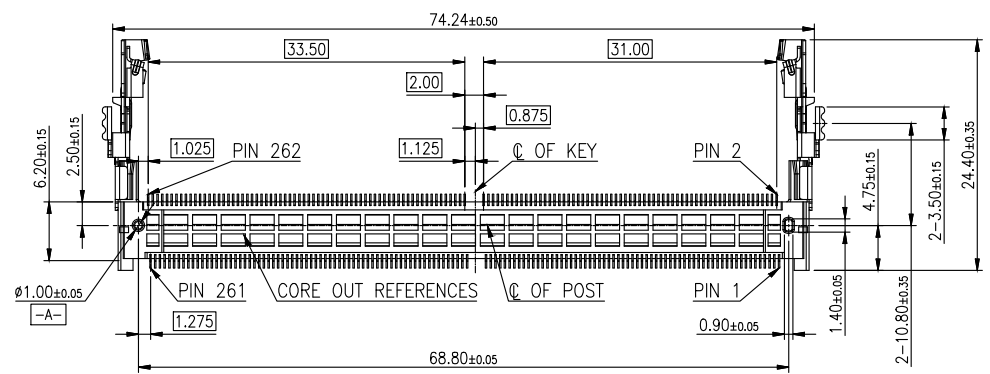
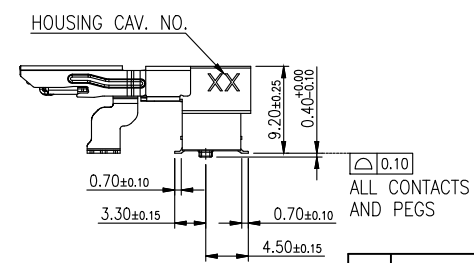
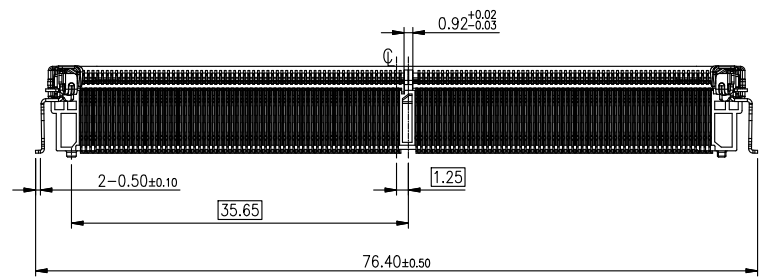
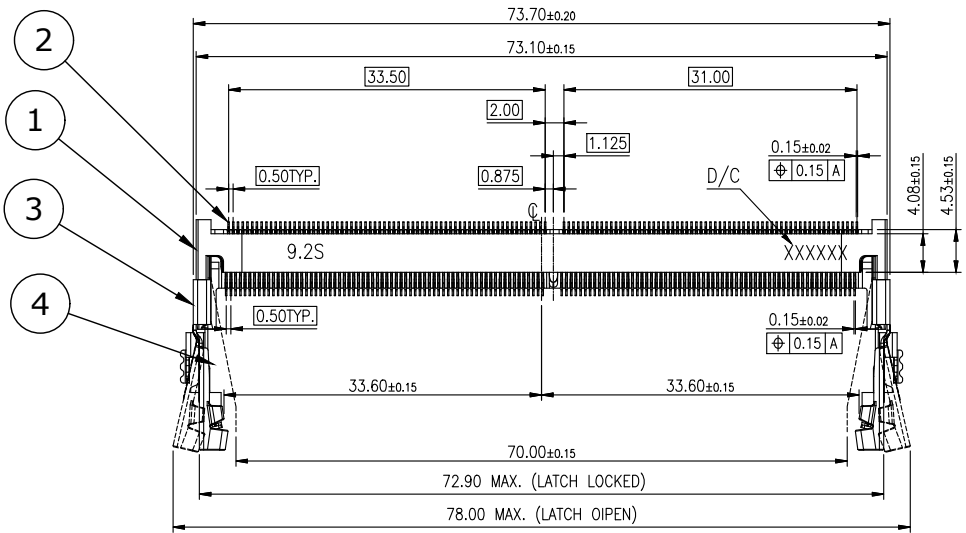

4	PEG	Stainless steel, 50u"~150u" matte tin plating over 50u"~150u" nickel plating
3	LATCH	Stainless steel
2	CONTACT	Copper alloy, 1u" gold plating on contact and solder area, under plating nickel
1	HOUSING	Thermoplastic, UL94V-0, Black

NO.		PART NAME	DESCRIPTION	
UNLESS OTHERWISE SPECIFIED TOLERANCE				
UNIT:	DECIMAL	LINEAR	ANGLES	
	X.	±0.50	±5°	
	X.X	±0.25	±3°	
	X.XX	±0.12	±1°	
mm			www.attend.com.tw	
DRAWN	Fros	2021/03/23	DRAWN NAME: DDR5 SODIMM Socket, Horizontal 9.2H, STD, G/F, Black, Reel, Solder PEG	
CHECKED	Tim	2021/03/23		
APPROVED	Ken	2021/03/23	PRODUCT NO. 126A-92A00	
SCALE	1.25	SHEET 1/2	SIZE A4	FILE NAME 126A-92A00_B_1



G
F
E
D
C
B
A

G
F
E
D
C
B
A

REV.	DESCRIPTION	DRAWN	DATE
	see sheet one		

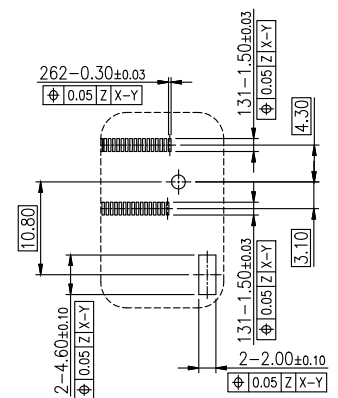
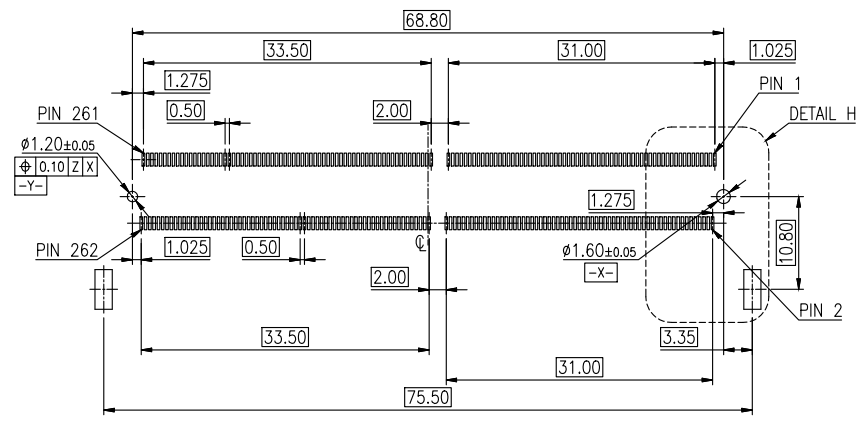

RECOMMEND P.C.BOARD LAYOUT
 PCB THICKNESS 0.80mm MIN.
 PCB LAYOUT GENERIC TOLERANCE:±0.05
 ([-Z-]:PCB SURFACE)

DETAIL H
 SCALE 1:1

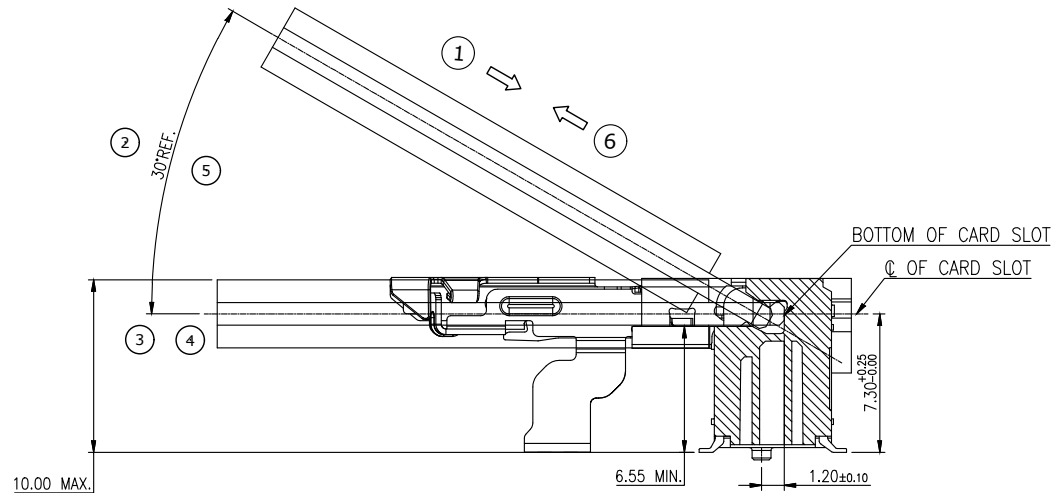

MATING: ① INSERTING → ② ROTATING → ③ FIXED
 UNMATING: ④ UNFIXED → ⑤ RISE UP → ⑥ EXTRACTING

MATING/UNMATING VIEW

UNLESS OTHERWISE SPECIFIED TOLERANCE

UNIT:	DECIMAL	LINEAR	ANGLES
mm	X.	±0.50	±5°
	X.X	±0.25	±3°
	X.XX	±0.12	±1°



www.attend.com.tw

DRAWN	Fros	2021/03/23	DRAWN NAME:	DDR5 SODIMM Socket, Horizontal
CHECKED	Tim	2021/03/23		9.2H, STD, G/F, Black, Reel, Solder PEG
APPROVED	Ken	2021/03/23	PRODUCT NO.	126A-92A00
	SCALE 1.25	SHEET 2/2	SIZE A4	FILE NAME 126A-92A00_B_1