

REV.	DESCRIPTION	DRAWN	DATE
1	INITIAL RELEASE	FROS	2021/03/23

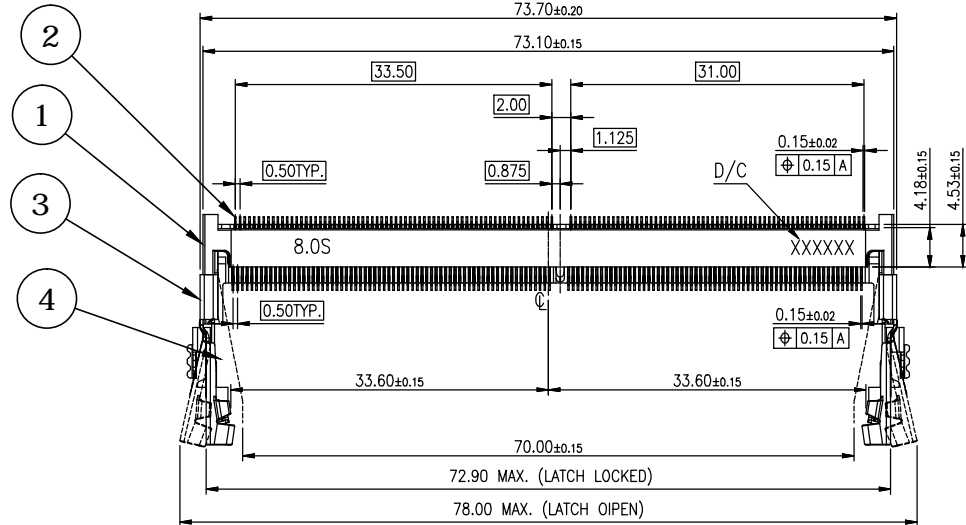

DATE CODE: YYWWD
 YY: YEAR
 WW: WEEK (01~52)
 D: DAY (1~7)

SPECIFICATION:

1. ELECTRICAL
 - 1.1 Current Rating: 0.6A per pin
 - 1.2 Voltage Rating: 25V AC
 - 1.3 Contact Resistance: 60mΩ max.
 - 1.4 Insulation Resistance: 100MΩ
 - 1.5 Dielectric Withstanding Voltage: 500VAC

2. MECHANICAL
 - 2.1 Durability: 50 Cycle
 - 2.2 Insertion Force: 59.8N max.
 - 2.3 Extraction Force: 44.6N max.

3. ENVIRONMENTAL
 - 3.1 Operating temperature range: -40°C~+85°C
 - 3.2 Storage temperature range: -40°C~+85°C

4. SOLDER ABILITY
 - 4.1 Recommended IR-Reflow Temperature: 260°C

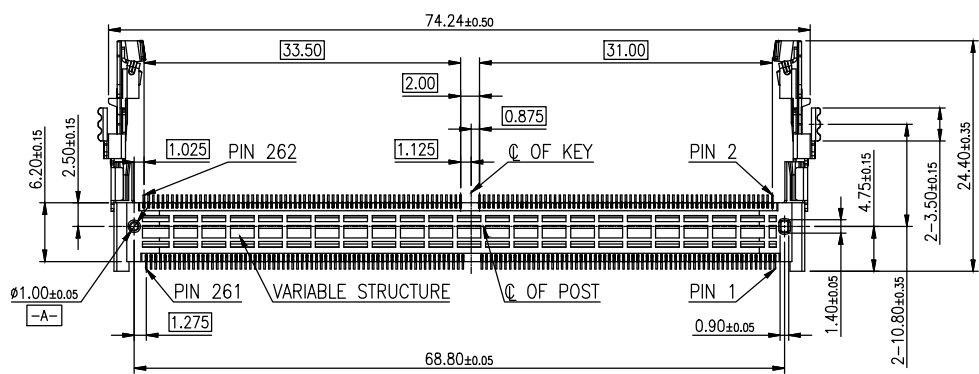
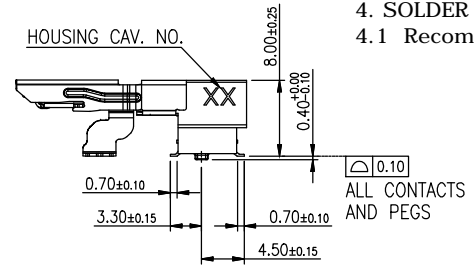
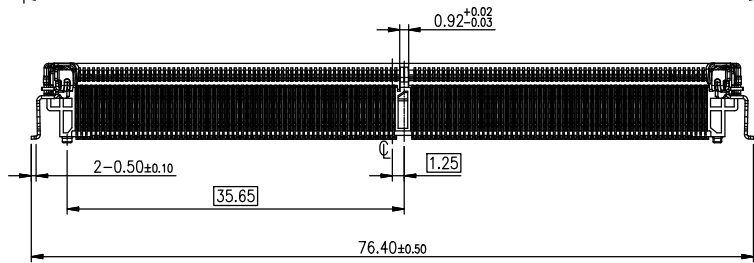

4	PEG	Stainless steel, 50u"~150u" matte tin plating over 50u"~150u" nickel plating
3	LATCH	Stainless steel
		Copper alloy, 1u" gold plating on contact and solder area, under plating nickel
2	CONTACT	
1	HOUSING	Thermoplastic, UL94V-0, Black

NO.		PART NAME		DESCRIPTION	
UNLESS OTHERWISE SPECIFIED TOLERANCE					
UNIT:	DECIMAL	LINEAR	ANGLES		
	X.	±0.50	±5°		
	X.X	±0.25	±3°		
	X.XX	±0.12	±1°		
DRAWN	Fros	2021/03/23	DRAWN NAME:		
CHECKED	Tim	2021/03/23	DDR5 SODIMM Socket, Horizontal 8.0H, STD, G/F, Black, Reel, Solder PEG		
APPROVED	Ken	2021/03/23	PRODUCT NO.	126A-80A00	
SCALE	1.25	SHEET	1/2	SIZE	A4
			FILE NAME	126A-80A00_B_1	



www.attend.com.tw

REV.	DESCRIPTION	DRAWN	DATE
	see sheet one		

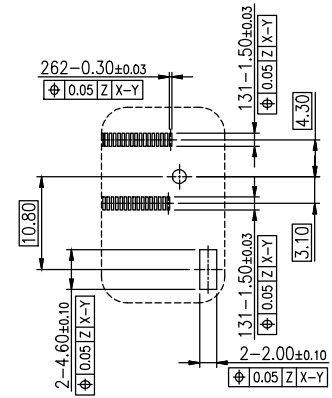
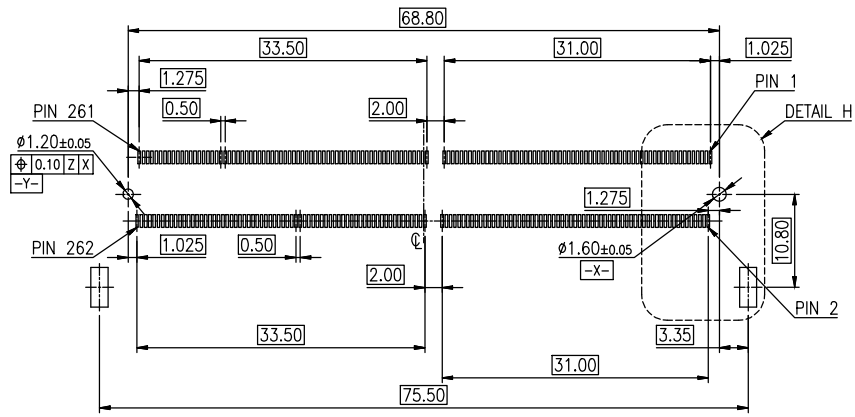

RECOMMEND P.C.BOARD LAYOUT
 PCB THICKNESS 0.80mm MIN.
 PCB LAYOUT GENERIC TOLERANCE:±0.05
 ([-Z-]:PCB SURFACE)

DETAIL H
 SCALE 1:1

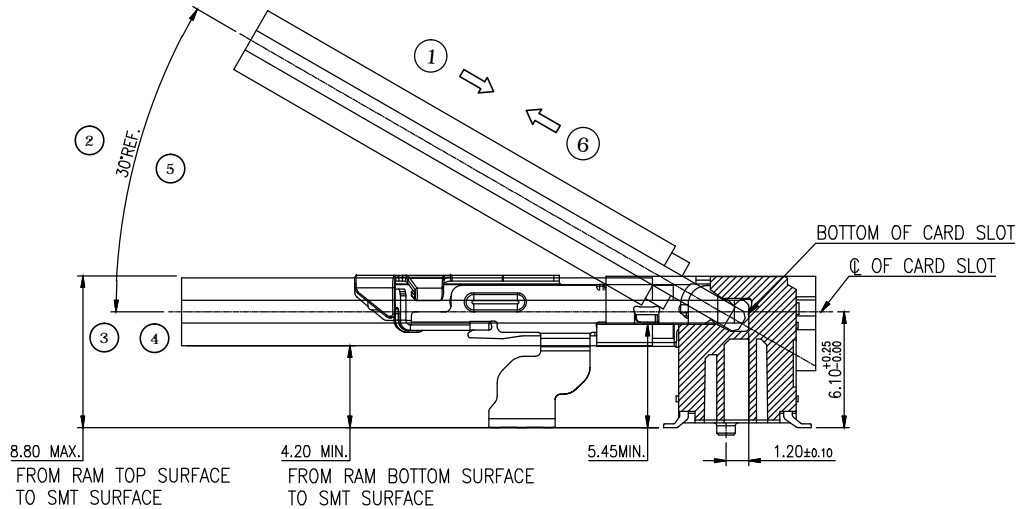

MATING: ① INSERTING → ② ROTATING → ③ FIXED
 UNMATING: ④ UNFIXED → ⑤ RISE UP → ⑥ EXTRACTING

MATING/UNMATING VIEW

UNLESS OTHERWISE SPECIFIED TOLERANCE				
UNIT:	DECIMAL	LINEAR	ANGLES	
mm	X.	±0.50	±5°	www.attend.com.tw
	X.X	±0.25	±3°	
	X.XX	±0.12	±1°	
DRAWN	Fros	2021/03/23	DRAWN NAME:	
CHECKED	Tim	2021/03/23	DDR5 SODIMM Socket, Horizontal 8.0H, STD, G/F, Black, Reel, Solder PEG	
APPROVED	Ken	2021/03/23	PRODUCT NO.	126A-80A00
SCALE	1.25	SHEET 2/2	SIZE	A4
			FILE NAME	126A-80A00_B_1

REV.	DESCRIPTION	DRAWN	DATE
1	INITIAL RELEASE	FROS	2021/03/23

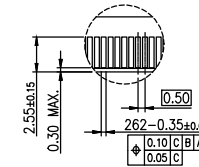
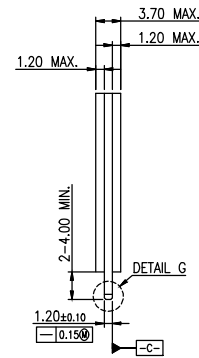
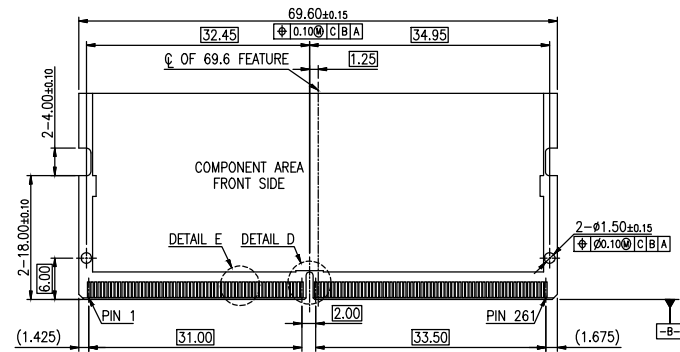

DETAIL E
SCALE 2:1

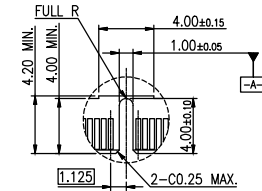

DETAIL D
SCALE 2:1

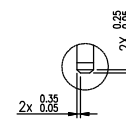
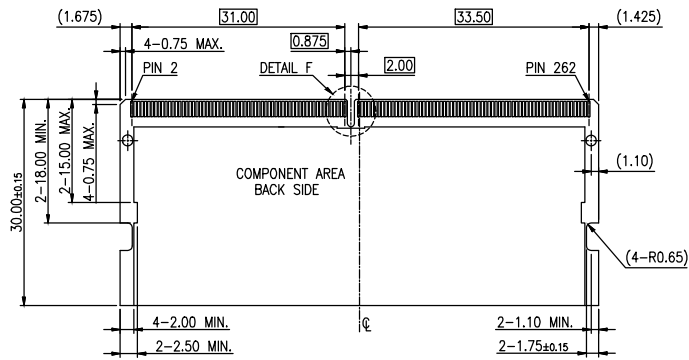

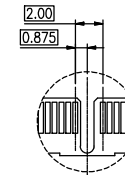

DETAIL G
SCALE 2:1



DETAIL F
SCALE 2:1

RECOMMEND MODULE CONFIGURATION

UNLESS OTHERWISE SPECIFIED TOLERANCE					
UNIT:	DECIMAL	LINEAR	ANGLES		
mm	X.	±0.50	±5°	www.attend.com.tw	
	X.X	±0.25	±3°		
	X.XX	±0.12	±1°		
DRAWN	Fros	2021/03/23	DRAWN NAME:		
CHECKED	Tim	2021/03/23	262 PIN DDR5 SODIMM, 0.5MM PITCH PACKAGE		
APPROVED	Ken	2021/03/23	PRODUCT NO.		
	SCALE 1.25	SHEET 1/1	SIZE A4	FILE NAME	126A-CARD_B_1

REV.	DESCRIPTION	DRAWN	DATE
1	INITIAL RELEASE	FROS	2021/03/23

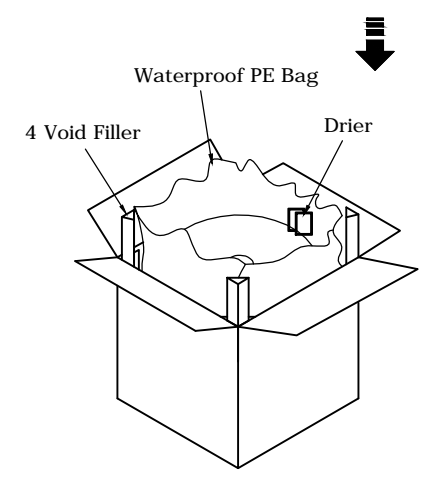
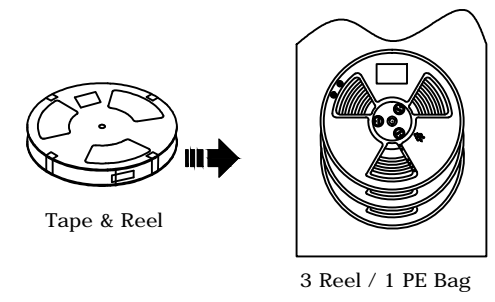
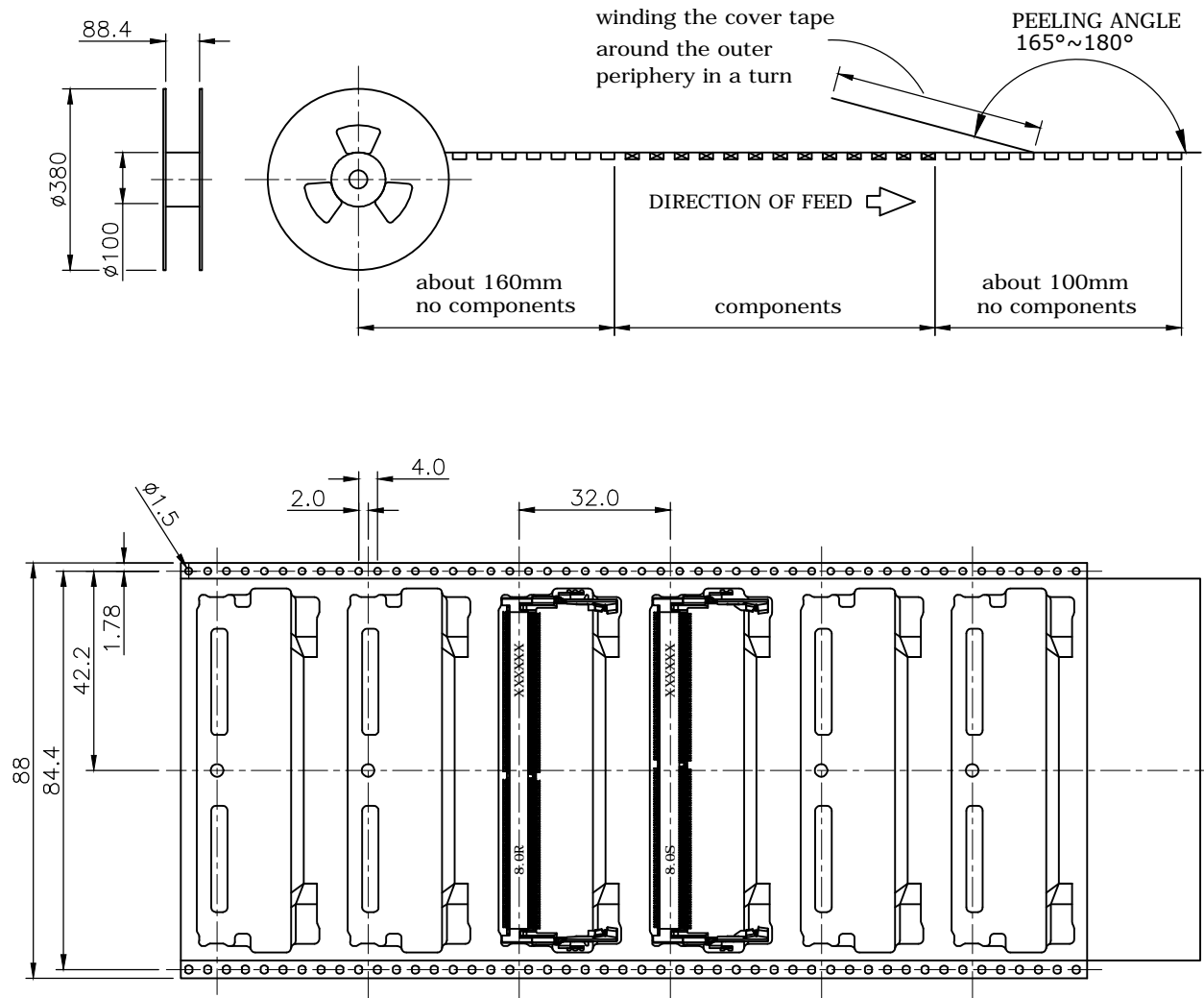

Carton L*W*H= 405*405*320

PART NO.	PCS/REEL	REEL/CARTON	PCS/CARTON
126A-80A00	300	3	900
126A-80A10	300	3	900

UNLESS OTHERWISE SPECIFIED TOLERANCE				 www.attend.com.tw	
UNIT:	DECIMAL	LINEAR	ANGLES		
mm	X.	±0.50	±5°		
	X.X	±0.25	±3°		
	X.XX	±0.12	±1°		
DRAWN	Fros	2021/03/23	DRAWN NAME: Packaging for DDR5 SODIMM Socket, Horizontal, 8.0H, Reel 88.0mm		
CHECKED	Tim	2021/03/23	PRODUCT NO. SEE TABLE		
APPROVED	Ken	2021/03/23	FILE NAME 126A-80AX0_D_1		
SCALE N/A		SHEET 1/1	SIZE A4		