

REV.	DESCRIPTION	DRAWN	DATE
1	INITIAL RELEASE	FROS	2016/08/17
2	CHANGE P/N	FROS	2016/10/11

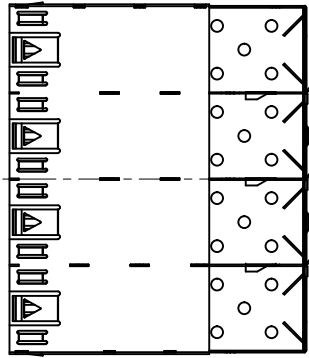

BOTTOM VIEW

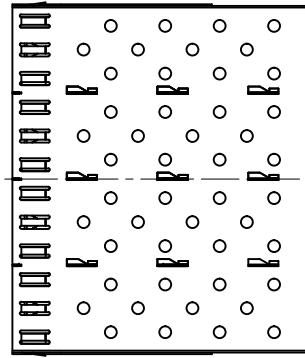

TOP VIEW

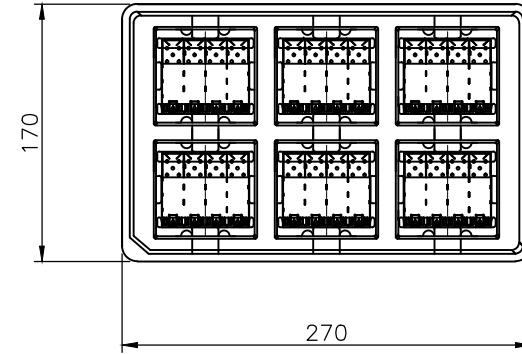

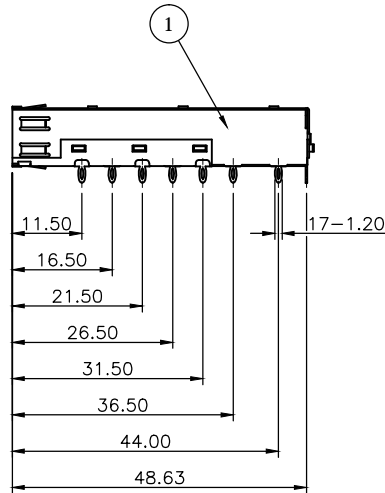
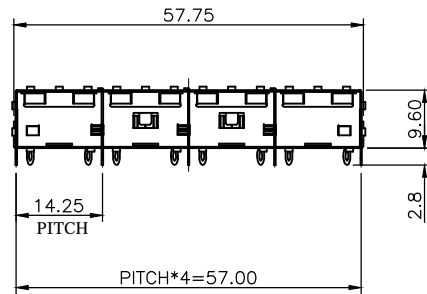

**PACKAGING SPECIFICATION:**

- 6pcs/ Vacuum Dish
- 204pcs/ Carton
- Vacuum Dish size: 270x170x16.5mm
- Carton: 365\*295\*365mm

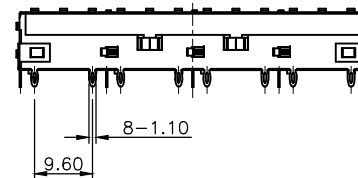

SEE BOTTOM VIEW



1	CAGE	Copper alloy, Nickel plating		
NO.	PART NAME	DESCRIPTION		
UNLESS OTHERWISE SPECIFIED TOLERANCE				
UNIT:	DECIMAL	LINEAR	ANGLES	
mm	X.	±0.50	±5°	
	X.X	±0.25	±3°	
	X.XX	±0.12	±1°	
 <a href="http://WWW.ATTEND.COM.TW">WWW.ATTEND.COM.TW</a>				
DRAWN	Fros	2016/08/17	DRAWN NAME:	
CHECKED	Tim	2016/08/17	SFP Cage 1x4 Press Fit Type	
APPROVED	Ken	2016/08/17	PRODUCT NO.	223A-1401
SCALE 1/1		SHEET 1/2	SIZE A4	FILE NAME 223A-1401_B_2

REV.	DESCRIPTION	DRAWN	DATE
	SEE SHEET ONE		

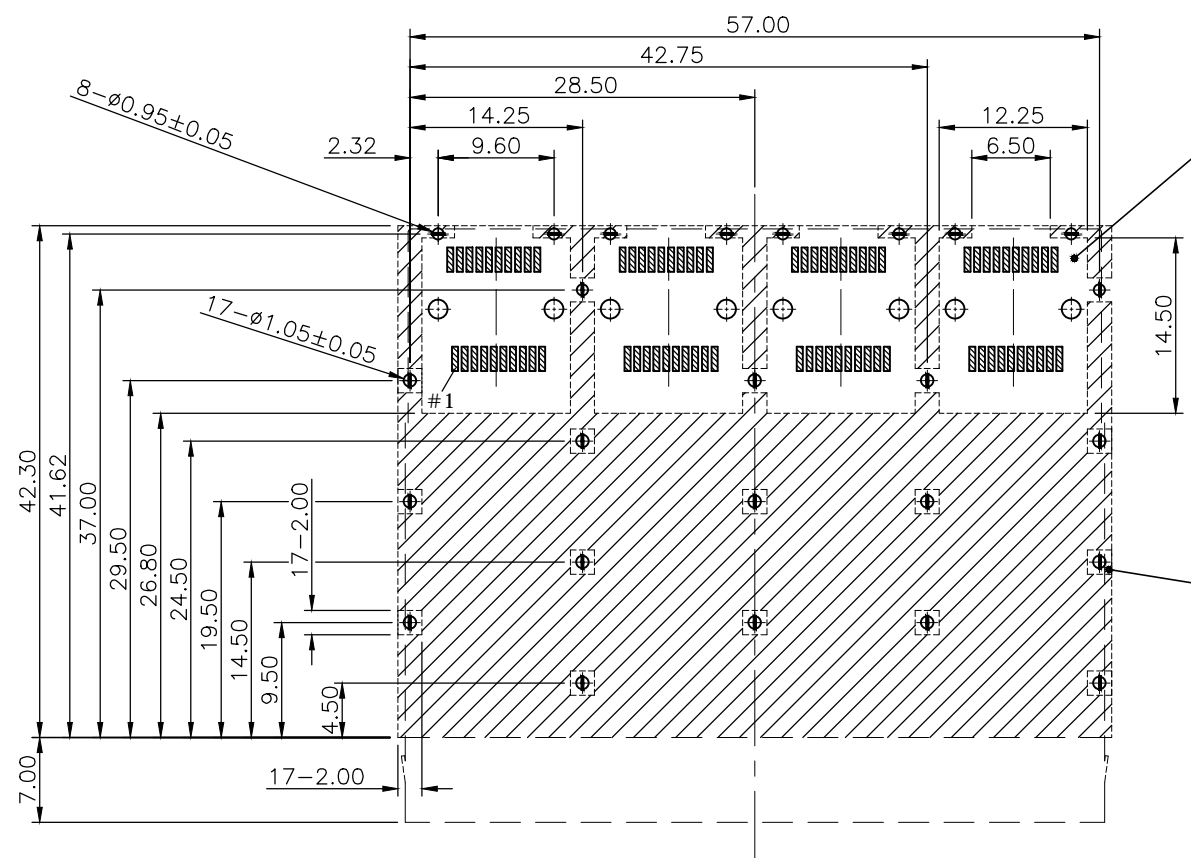

This area denotes component keep-out (traces allowed)

- Cage Boundary
- Component and trace keep-out (except chassis ground)
- Connector PAD

PADS and VIAS are chassis ground

**Recommended Layout (top view)**  
**General Tolerance: ±0.05mm**

UNLESS OTHERWISE SPECIFIED TOLERANCE				 WWW.ATTEND.COM.TW		
UNIT:	DECIMAL	LINEAR	ANGLES			
mm	X.	±0.50	±5°			
	X.X	±0.25	±3°			
	X.XX	±0.12	±1°			
DRAWN	Fros	2016/08/17	DRAWN NAME:			
CHECKED	Tim	2016/08/17	SFP Cage 1x4 Press Fit Type			
APPROVED	Ken	2016/08/17	PRODUCT NO.	223A-1401		
	SCALE	SHEET	SIZE	FILE NAME		
	1.6/1	2/2	A4	223A-1401_B_2		

REV.	DESCRIPTION	DRAWN	DATE
3	Add new P/N to 5u" plating	FROS	2016/08/17
4	CHANGE P/N	FROS	2016/10/11
5	Corrected	FROS	2019/05/06

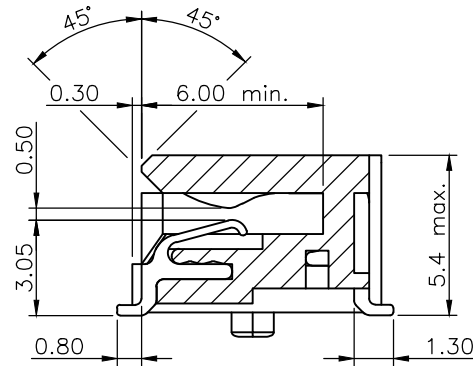
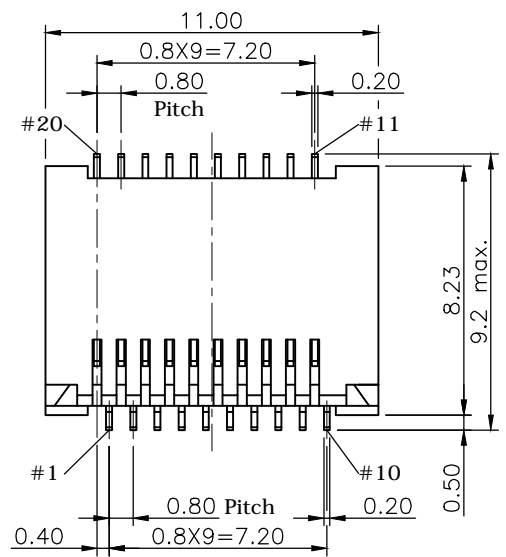

**SECTION A-A**

**SPECIFICATION:**

**1. ELECTRICAL**

- 1.1 Current Rating: 0.5A MAX.
- 1.2 Voltage Rating: 30V AC/DC
- 1.3 Contact Resistance: 20mΩ
- 1.4 Insulation Resistance: 500MΩ
- 1.5 Differential Impedance: 100Ω

**2. MECHANICAL**

**2.1 MATERIAL:**

- Housing: LCP UL94V-0, Black
- Contact: Phosphor Bronze, 0.2T
- 2.2 Operating Life : 250 Cycles Min.

**3. ENVIRONMENTAL**

- 3.1 Operating temperature range: -40°C ~ +85°C
- 3.2 Storage temperature range: -40°C ~ +85°C
- 3.3 IR Temperature: 255°C±5°C (5 to 10 sec)

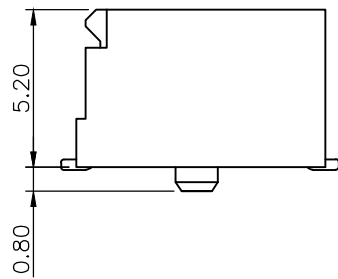
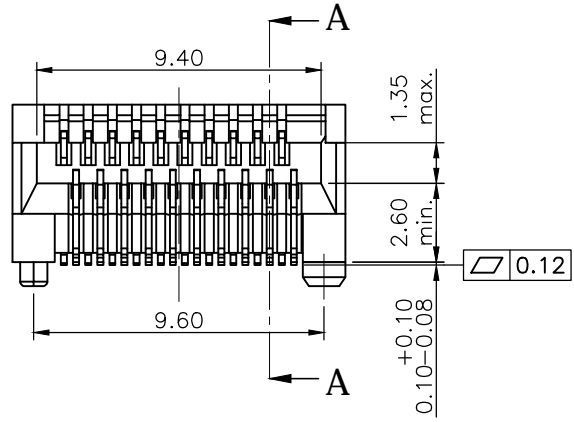



**How to order**

223A- 00 C 0

Connector

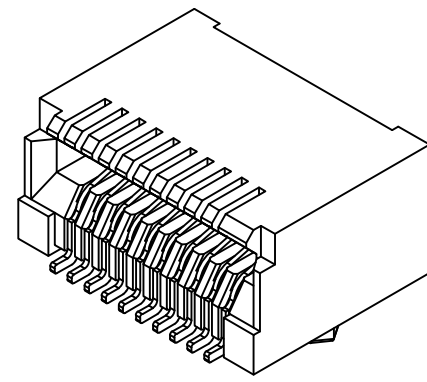
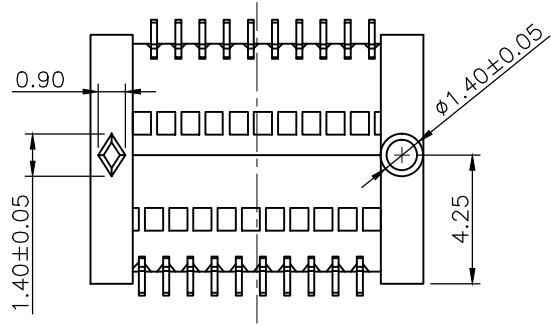
5u" Gold plating



UNLESS OTHERWISE SPECIFIED TOLERANCE					
UNIT:	DECIMAL	LINEAR	ANGLES		
mm	X.	±0.50	±5°	WWW.ATTEND.COM.TW	
	X.X	±0.25	±3°		
	X.XX	±0.12	±1°		
DRAWN	Willis	2009/10/14	DRAWN NAME: 1x1 SFP/SFP+ Connector 20Pin		
CHECKED	Angel	2009/10/14			
APPROVED	Ken	2009/10/14	PRODUCT NO.	223A-00C0	
SCALE	4/1	SHEET	1/2	SIZE	A4
			FILE NAME	223A-00C0_B_5	

REV.	DESCRIPTION	DRAWN	DATE
	SEE SHEET ONE		

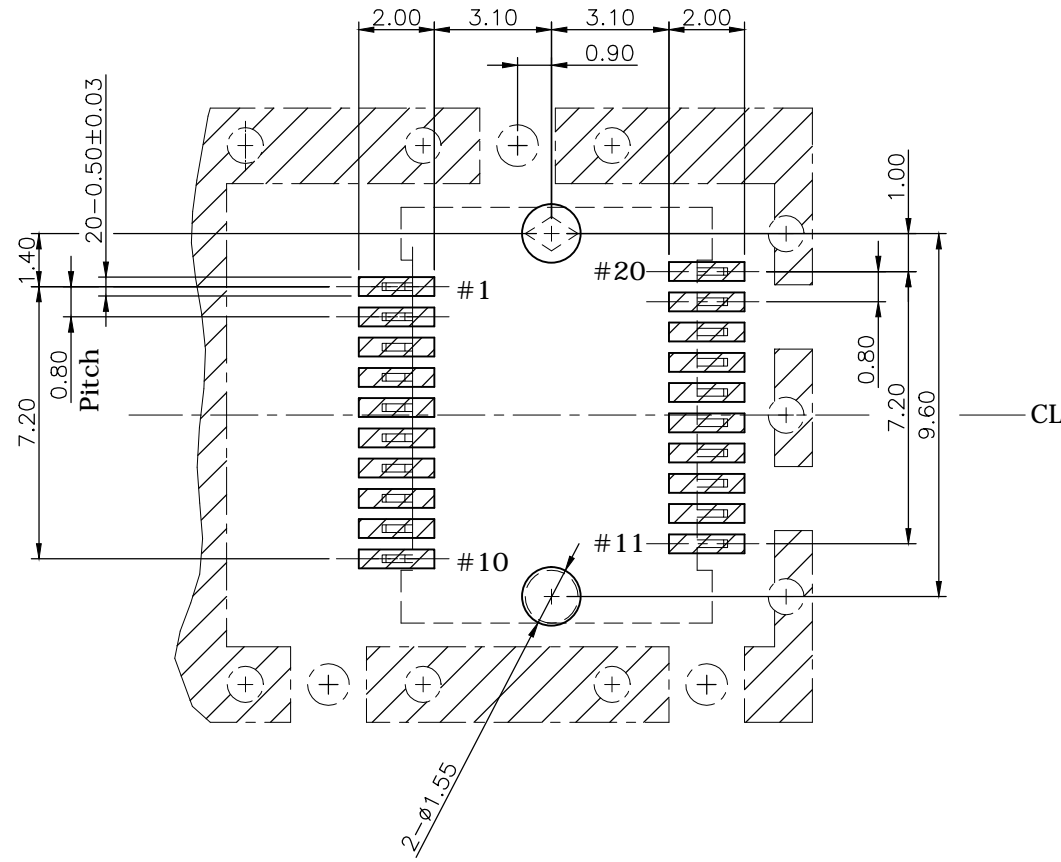

- SFP CONNECTOR
- PAD
- CAGE

**RECOMMENDED LAYOUT (TOP VIEW)**  
**GENERAL TOLERANCE: ±0.05mm**

UNLESS OTHERWISE SPECIFIED TOLERANCE							
UNIT:	DECIMAL	LINEAR	ANGLES			WWW.ATTEND.COM.TW	
mm	X.	±0.50	±5°			DRAWN NAME: 1x1 SFP/SFP+ Connector 20Pin	
	X.X	±0.25	±3°				
	X.XX	±0.12	±1°				
DRAWN	Willis	2009/10/14	DRAWN NAME: 1x1 SFP/SFP+ Connector 20Pin				
CHECKED	Angel	2009/10/14	DRAWN NAME: 1x1 SFP/SFP+ Connector 20Pin				
APPROVED	Ken	2009/10/14	PRODUCT NO.	223A-00C0			
	SCALE	SHEET	SIZE	FILE NAME	223A-00C0_B_5		
	5/1	2/2	A4				